

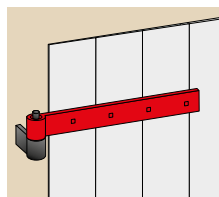

L'EXTÉRIEUR DE L'HABITAT

LE VOLET BOIS



Penture bout droit

Code	Gencod		D	L	I	Ep.	Type packaging		
30x4									
0662601	3308180035698		14	300	30	4	Vrac gencodé	5	
0662701	3308180035704		14	400	30	4	Vrac gencodé	5	
0662801	3308180035711		14	500	30	4	Vrac gencodé	5	
0662603	3308186626036	Z.BLANC	14	300	30	4	Vrac gencodé	5	
0662703	3308186627033	Z.BLANC	14	400	30	4	Vrac gencodé	5	
0662803	3308180038750	Z.BLANC	14	500	30	4	Vrac gencodé	5	
35x4									
0663001	3308180035735		14	300	35	4	Vrac gencodé	5	
0663101	3308180035742		14	400	35	4	Vrac gencodé	5	
0663201	3308180035759		14	500	35	4	Vrac gencodé	5	
0663401	3308180035766		14	600	35	4	Vrac gencodé	5	
0663601	3308180035773		14	700	35	4	Vrac gencodé	5	
0663701	3308180035780		14	800	35	4	Vrac gencodé	5	
0663003	3308180037265	Z.BLANC	14	300	35	4	Vrac gencodé	5	
0663103	3308180038408	Z.BLANC	14	400	35	4	Vrac gencodé	5	
0663203	3308186632037	Z.BLANC	14	500	35	4	Vrac gencodé	5	
0663403	3308186634031	Z.BLANC	14	600	35	4	Vrac gencodé	5	
0663603	3308186636035	Z.BLANC	14	700	35	4	Vrac gencodé	5	
0663703	3308186637032	Z.BLANC	14	800	35	4	Vrac gencodé	5	
0943201	3308189432016		14	300	35	4		20	
0943301	3308189433013		14	400	35	4		20	
0943401	3308189434010		14	500	35	4		10	
0943501	3308189435017		14	600	35	4		10	
35x5									
0977201	3308189772013		14	300	35	5	Vrac gencodé	5	
1113201	3308181132013		14	400	35	5	Vrac gencodé	5	
1113101	3308181131016		14	500	35	5	Vrac gencodé	5	
0733601	3308180035797		14	600	35	5	Vrac gencodé	5	
0733801	3308180035803		14	700	35	5	Vrac gencodé	5	
0786901	3308180035827		14	800	35	5	Vrac gencodé	5	
40x5									
0733901	3308187339010		14	800	40	5	Vrac gencodé	5	
0265401	3308182654019		14	1000	40	5	Vrac gencodé	5	
0707306	3308187073006	DP	14	300	40	5	Vrac gencodé	5	
0707406	3308187074003	DP	14	400	40	5	Vrac gencodé	5	
0707506	3308187075000	DP	14	500	40	5	Vrac gencodé	5	
0707606	3308187076007	DP	14	600	40	5	Vrac gencodé	5	
0787901	3308180035865		16	800	40	5	Vrac gencodé	5	
0789101	3308180035940		16	1000	40	5	Vrac gencodé	5	
0797701	3308180035988		16	1200	40	5	Vrac gencodé	5	
0787903	3308180035872	Z.BLANC	16	800	40	5	Vrac gencodé	5	
0789103	3308180035957	Z.BLANC	16	1000	40	5	Vrac gencodé	5	
0797703	3308180035995	Z.BLANC	16	1200	40	5	Vrac gencodé	5	
40x6									
0977301	3308189773010		14	300	40	6	Vrac gencodé	5	
0977401	3308189774017		14	400	40	6	Vrac gencodé	5	
0977501	3308189775014		14	500	40	6	Vrac gencodé	5	
0977601	3308189776011		14	600	40	6	Vrac gencodé	5	
0977701	3308189777018		14	700	40	6	Vrac gencodé	5	
0977801	3308189778015		14	800	40	6	Vrac gencodé	5	
0977901	3308189779012		14	1000	40	6	Vrac gencodé	5	

Pentures coudées bout droit

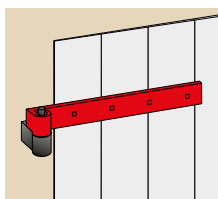

Penture coudée bout droit

Code	Gencod		D	L	I	Ep.	Type packaging	
35x4								
0793801	3308180036879		14	400	35	4	Vrac gencodé	1
0794601	3308180036916		14	500	35	4	Vrac gencodé	1
0794701	3308180038590		14	600	35	4	Vrac gencodé	1

Pentures queue de carpe

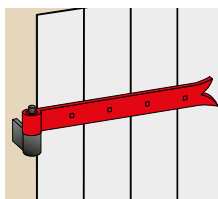
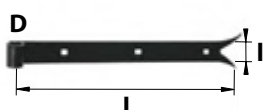

Penture bout queue de carpe

Code	Gencod		D	L	I	Ep.	Type packaging	
30x4								
0663801	3308180036053		14	300	30	4	Vrac gencodé	5
0663901	3308180036060		14	400	30	4	Vrac gencodé	5
0664801	3308180036077		14	500	30	4	Vrac gencodé	5
0663803	3308186638039	Z.BLANC	14	300	30	4	Vrac gencodé	5
0663903	3308186639036	Z.BLANC	14	400	30	4	Vrac gencodé	5
0664803	3308180038781	Z.BLANC	14	500	30	4	Vrac gencodé	5
35x4								
0665801	3308180036091		14	300	35	4	Vrac gencodé	5
0665901	3308180036107		14	400	35	4	Vrac gencodé	5
0667001	3308180036114		14	500	35	4	Vrac gencodé	5
0667501	3308180036121		14	600	35	4	Vrac gencodé	5
0667701	3308180036138		14	700	35	4	Vrac gencodé	5
0667801	3308180036145		14	800	35	4	Vrac gencodé	5
0665803	3308180038415	Z.BLANC	14	300	35	4	Vrac gencodé	5
0665903	3308180038422	Z.BLANC	14	400	35	4	Vrac gencodé	5
0667003	3308186670039	Z.BLANC	14	500	35	4	Vrac gencodé	5
0667703	3308186677038	Z.BLANC	14	700	35	4	Vrac gencodé	5
0943601	3308189436014		14	300	35	4		20
0943701	3308189437011		14	400	35	4		20
0943801	3308189438018		14	500	35	4		10
0943901	3308189439015		14	600	35	4		10
35x5								
0808501	3308188085015		14	300	35	5	Vrac gencodé	5
0808701	3308188087019		14	400	35	5	Vrac gencodé	5
0808901	3308188089013		14	500	35	5	Vrac gencodé	5
0809101	3308188091016		14	600	35	5	Vrac gencodé	5
40x5								
0735501	3308187355010		14	800	40	5	Vrac gencodé	5
0265501	3308182655016		14	1000	40	5	Vrac gencodé	5
0788301	3308180036220		16	800	40	5	Vrac gencodé	5
0789301	3308180036305		16	1000	40	5	Vrac gencodé	5
0797801	3308180036343		16	1200	40	5	Vrac gencodé	5

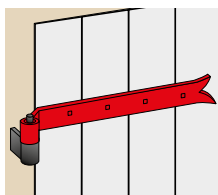
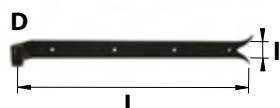

Penture col équerre bout queue de carpe

Code	Gencod		D	L	I	Ep.	Type packaging	
35x4								
0785601	3308187856012		14	500	35	4	Vrac gencodé	1
0785701	3308187857019		14	600	35	4	Vrac gencodé	1

Equerres bout droit

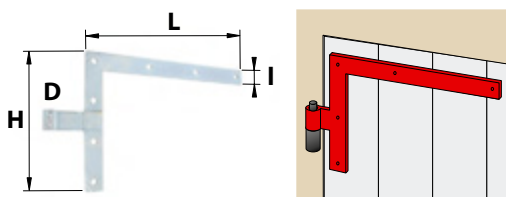
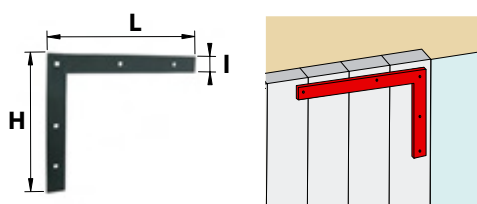
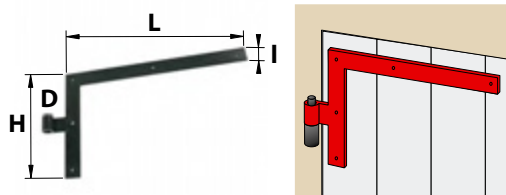

Equerre bout droit

Code	Gencod		D	L	H	I	Ep.	Déport	Type packaging	
Modèle haut gauche / bas droit										
0819701	3308180037616		14	300	250	35	4	50	Vrac gencodé	1
Modèle haut droit / bas gauche										
0819601	3308180037579		14	300	250	35	4	50	Vrac gencodé	1
La paire										
0389701	3308183897019		14	300	250	35	4	50	Vrac gencodé	1
0944001	3308189440011		14	300	250	35	4	50		4
Modèle haut gauche / bas droit										
176010	3221681760107		16	800	400	40	6	37	Vrac gencodé	1
Modèle haut droit / bas gauche										
176011	3221681760114		16	800	400	40	6	37	Vrac gencodé	1

Contre-équerre bout droit

Code	Gencod		L	H	I	Ep.	Type packaging	
0459401	3308184594016		300	250	35	4	Vrac gencodé	1

Equerre bout droit

Code	Gencod		D	L	H	I	Ep.	Déport	Type packaging	
Modèle haut gauche / bas droit										
752805	3026727528051	Z.BLANC	14	300	220	30	4	55	Vrac gencodé	4
Modèle haut droit / bas gauche										
752804	3026727528044	Z.BLANC	14	300	220	30	4	55	Vrac gencodé	4

Equerres queue de carpe

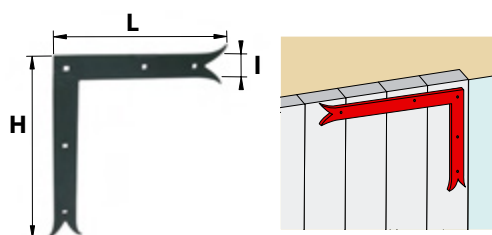
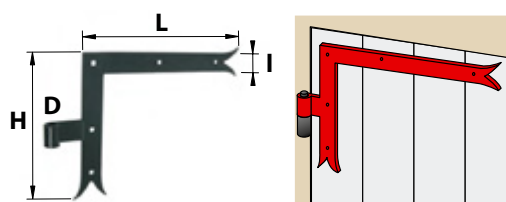

Equerre bout queue de carpe

Code	Gencod		D	L	H	I	Ep.	Déport	Type packaging	
Modèle haut gauche / bas droit										
0793201	3308180037739		14	300	250	35	4	50	Vrac gencodé	1
Modèle haut droit / bas gauche										
0793401	3308180037692		14	300	250	35	4	50	Vrac gencodé	1
La paire										
0382801	3308183828013		14	300	250	35	4	50	Vrac gencodé	1

Contre-équerre bout queue de carpe

Code	Gencod		L	H	I	Ep.	Type packaging	
0792801	3308180037814		300	250	35	4	Vrac gencodé	1

Tés bout droit

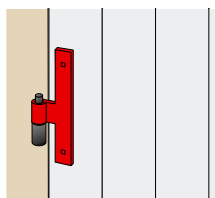
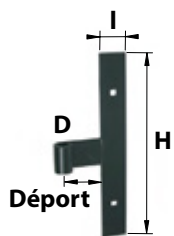

Té bout droit

Code	Gencod		D	H	I	Ep.	Déport	Type packaging	
0819801	3308180037654		14	250	35	4	50	Vrac gencodé	1
0819803	3308180037661	Z.BLANC	14	250	35	4	50	Vrac gencodé	1
0942601	3308189426015		14	250	35	4	50		15

Tés queue de carpe

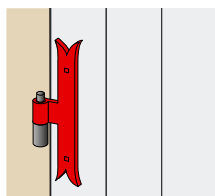
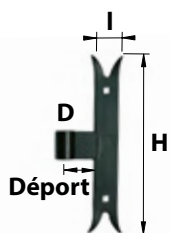

Té bout queue de carpe

Code	Gencod		D	H	I	Ep.	Déport	Type packaging	
0793001	3308180037777		14	250	35	4	50	Vrac gencodé	1

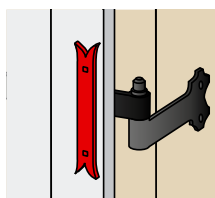

Contre-té bout queue de carpe

Code	Gencod		H	I	Ep.	Type packaging	
0793601	3308180037852		250	35	4	Vrac gencodé	1

Kit penture

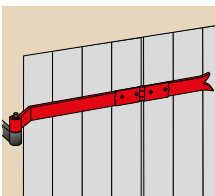
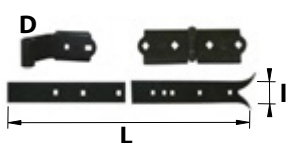

Kit penture spécial volet double

Code	Gencod		D	L	I	Ep.	Type packaging	
0109405	3308181094052		14	1123	35	4	Vrac gencodé	1

Composition

Nœud déporté D14 - Charnière - Éléments de penture recoupables.

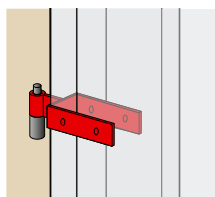
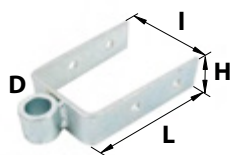

Penture nord U

Code	Gencod		D	L	H	I	Ep.	Type packaging	
M685900	3026726859002	Z.BLANC	14	135	35	80	5	Vrac gencodé	5

Pentures festonnées

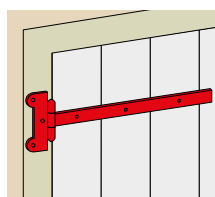

Penture festonnée

Code	Gencod		L	I	Ep.	Type packaging	
629460	3479046294600		300	30	4	Vrac gencodé	5
629465	3479046294655		400	30	4	Vrac gencodé	5
629470	3479046294709		500	30	4	Vrac gencodé	5
629475	3479046294754		600	30	4	Vrac gencodé	5
9629600	3479046296000	Z.BLANC	300	30	4	Vrac gencodé	5
629605	3479046296055	Z.BLANC	400	30	4	Vrac gencodé	5
629610	3479046296109	Z.BLANC	500	30	4	Vrac gencodé	5
629615	3479046296154	Z.BLANC	600	30	4	Vrac gencodé	5

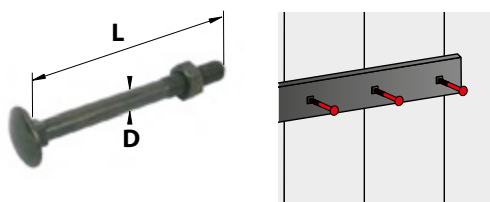

Boulon TRCC

Code	Gencod		D	L	Type packaging	
x8						
629765	3221686297653		6	45	Brochable gencodé	1
629767	3221686297677		6	70	Brochable gencodé	1
0955504	3308189555043		7	45	Brochable gencodé	1
629798	3221686297981		7	60	Brochable gencodé	1
0955604	3308189556040		7	70	Brochable gencodé	1
629793	3221686297936	Z.BLANC	7	45	Brochable gencodé	1
629797	3221686297974	Z.BLANC	7	70	Brochable gencodé	1
x30						
629761	3221686297615		6	45	Brochable gencodé	1
629763	3221686297639		6	70	Brochable gencodé	1
629791	3221686297912		7	45	Brochable gencodé	1
629799	3221686297998		7	60	Brochable gencodé	1
629795	3221686297950		7	70	Brochable gencodé	1

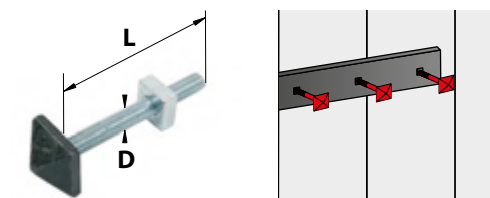

Boulon tête diamant (x4)

Code	Gencod		D	L	Type packaging	
0953401	3308189534017		7	60	Brochable gencodé	1

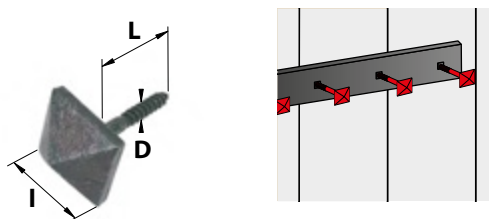

Clou vis tête diamant (x4)

Code	Gencod		D	L	I	Type packaging	
0996600	3308189966009		5	37	15	Brochable gencodé	1
0996700	3308189967006		5	37	25	Brochable gencodé	1

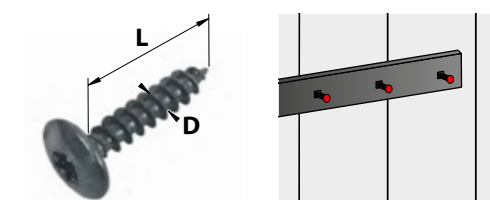

Vis peinture

Code	Gencod		D	L	Type packaging	
x8						
0254201	3308182542019		7	30	Brochable gencodé	1
0254601	3308182546017		7	50	Brochable gencodé	1
x30						
0996900	3308189969000	Z.BLANC	6	30	Brochable gencodé	1
0997000	3308189970006		6	30	Brochable gencodé	1
629780	3221686297806		7	30	Brochable gencodé	1
0996800	3308189968003		7	50	Brochable gencodé	1

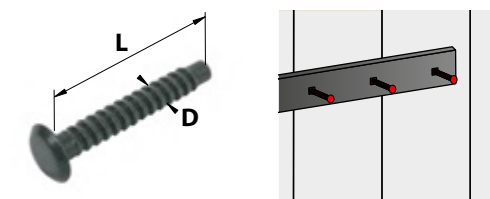

Vis peinture sécurité (x20)

Code	Gencod		D	L	Type packaging	
0953204	3308189532044		7	45	Brochable gencodé	1

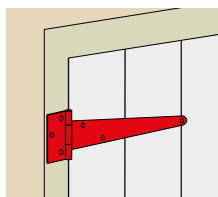
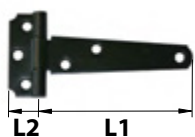

Penture anglaise légère

Code	Gencod		L1	L2	Ep.	Type packaging	
0503401	3308185034016		75	20,5	1,5	Vrac gencodé	10
0503501	3308185035013		100	20,5	1,5	Vrac gencodé	10
0095704	3308180957044		125	20,5	1,5	Vrac gencodé	10
0503402	3308185034023	Z.BLANC	75	20,5	1,5	Vrac gencodé	10
0503502	3308185035020	Z.BLANC	100	20,5	1,5	Vrac gencodé	10
0095702	3308180957020	Z.BLANC	125	20,5	1,5	Vrac gencodé	10
0503602	3308185036027	Z.BLANC	150	43,7	1,5	Vrac gencodé	10
0240802	3308182408025	Z.BLANC	75	20,5	1,5		50
0240902	3308182409022	Z.BLANC	100	20,5	1,5		30
0241002	3308182410028	Z.BLANC	125	20,5	1,5		50
0330302	3308183303022	Z.BLANC	150	43,7	1,5		20

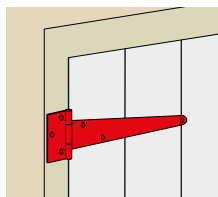
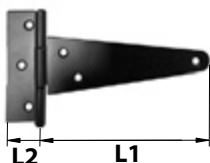

Penture anglaise

Code	Gencod		L1	L2	Ep.	Type packaging	
9624100	3479046241000		80	25	1,5	Vrac gencodé	10
624105	3479046241055		100	25	1,5	Vrac gencodé	10
624110	3479046241109		120	25	1,5	Vrac gencodé	10
624115	3479046241154		150	25	1,5	Vrac gencodé	10
624090	3479046240904	Z.BLANC	80	25	1,5	Vrac gencodé	10
1902102	3479046240911	Z.BLANC	100	25	1,5	Vrac gencodé	10
624092	3479046240928	Z.BLANC	120	25	1,5	Vrac gencodé	10
0330302	3308183303022	Z.BLANC	150	43,7	1,5		20

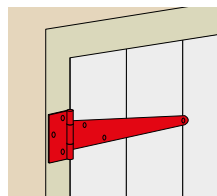

Penture anglaise

Code	Gencod		L1	L2	Ep.	Type packaging	
624155	3479046241550		200	42,7	2	Vrac gencodé	10
624160	3479046241604		250	42,7	2	Vrac gencodé	10
624165	3479046241659		300	42,7	2	Vrac gencodé	10
624170	3479046241703		350	42,7	2	Vrac gencodé	10
624094	3479046240942	Z.BLANC	200	42,7	2	Vrac gencodé	10
624095	3479046240959	Z.BLANC	250	42,7	2	Vrac gencodé	10
624096	3479046240966	Z.BLANC	300	42,7	2	Vrac gencodé	10
624070	3479046240706	Z.BLANC	350	42,7	2	Vrac gencodé	10
0241102	3308182411025	Z.BLANC	200	42,7	2		20
0241202	3308182412022	Z.BLANC	300	42,7	2		30

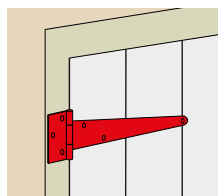

Penture anglaise forte

Code	Gencod		L1	L2	Ep.	Type packaging	
8207015	3221688207018		150	41,7	2,5	Vrac gencodé	10
8207020	3221688207216		200	41,7	2,5	Vrac gencodé	10
8207025	3221688207261		250	41,7	2,5	Vrac gencodé	10
8207030	3221688207315		300	41,7	2,5	Vrac gencodé	10
8207035	3221688207353		350	41,7	2,5	Vrac gencodé	10
8207040	3221688207407		400	41,7	2,5	Vrac gencodé	10
8207050	3221688207506		500	41,7	2,5	Vrac gencodé	10
8207060	3221688207605		600	41,7	2,5	Vrac gencodé	10
7207150	3221687207156		150	41,7	2,5	Vrac gencodé	10
7207200	3221687207200		200	41,7	2,5	Vrac gencodé	10
7207250	3221687207255		250	41,7	2,5	Vrac gencodé	10
7207300	3221687207309		300	41,7	2,5	Vrac gencodé	10
7207350	3221687207354		350	41,7	2,5	Vrac gencodé	10
7207400	3221687207408		400	41,7	2,5	Vrac gencodé	10
7207500	3221687207507		500	41,7	2,5	Vrac gencodé	10
7207600	3221687207606		600	41,7	2,5	Vrac gencodé	10
0465202	3308184652020		400	41,7	2,5		15
0465502	3308184655021		500	41,7	2,5		15
0465602	3308184656028		600	41,7	2,5		15

Penture anglaise avec axe composite

Code	Gencod		L1	L2	Ep.	Type packaging	
756915	3026727569153		144	45	2	Vrac gencodé	5
756920	3026727569207		194	45	2	Vrac gencodé	5
756925	3026727569252		244	45	2	Vrac gencodé	5
757930	3026727579305		292,8	45	2	Vrac gencodé	5
757935	3026727579350		342,8	45	2	Vrac gencodé	5
757940	3026727579404		392,8	45	2	Vrac gencodé	5
757950	3026727579503		492,8	45	2	Vrac gencodé	5
757960	3026727579602		572,8	45	2	Vrac gencodé	5
756815	3026727568156		144	45	2	Vrac gencodé	5
756820	3026727568200		194	45	2	Vrac gencodé	5
756825	3026727568255		244	45	2	Vrac gencodé	5
757830	3026727578308		292,8	45	2	Vrac gencodé	5
757835	3026727578353		342,8	45	2	Vrac gencodé	5
757840	3026727578407		392,8	45	2	Vrac gencodé	5
757850	3026727578506		492,8	45	2	Vrac gencodé	5
757860	3026727578605		572,8	45	2	Vrac gencodé	5

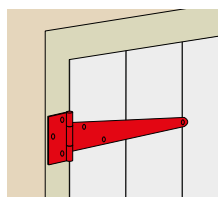
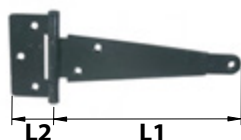

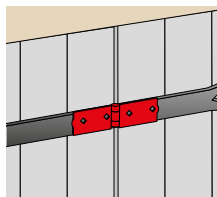
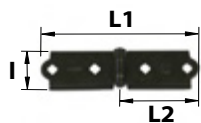

Charnière à penture

Code	Gencod		L1	L2	I	Type packaging	
110040	3221681100408		170	85	35	Vrac gencodé	1
110036	3221681100361		170	85	40	Vrac gencodé	1



Couplet niçois (x2) + visserie

Code	Gencod		H	I	Ep.	Type packaging	
0952501	3308189525015		158	47	2	Brochable gencodé	1

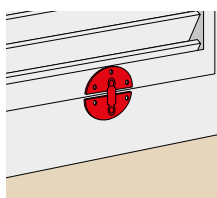
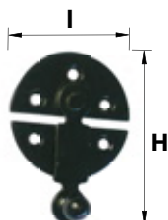

Violet niçois (x2) + visserie

Code	Gencod		H	I	Ep.	Type packaging	
0953101	3308189531016		95	65	2,5	Brochable gencodé	1

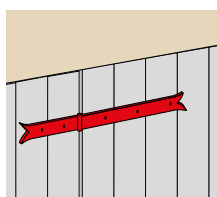

Charnière de jumelage bout queue de carpe

Code	Gencod		L1	L2	I	Ep.	Type packaging	
0742801	3308187428011		400	150	35	4	Vrac gencodé	1
0744601	3308187446015		500	150	35	6	Vrac gencodé	1

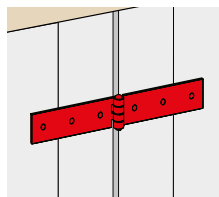
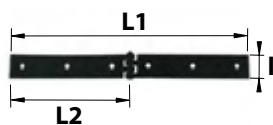

Charnière forte

Code	Gencod		L1	L2	I	Ep.	Type packaging	
0238801	3308182388013		200	100	40	4	Vrac gencodé	10
0238901	3308182389010		300	150	40	4	Vrac gencodé	10
0240001	3308182400012		400	200	40	4	Vrac gencodé	10

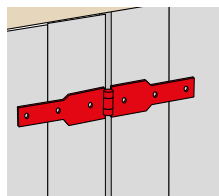
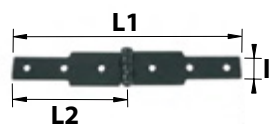

Charnière à congés

Code	Gencod		L1	L2	I	Ep.	Type packaging	
542350	3221685423503		200	100	30	2,5	Vrac gencodé	10
542360	3221685423602		240	120	40	2,5	Vrac gencodé	10
542370	3221685423701		280	140	50	2,5	Vrac gencodé	10
542320	3479045423209	Z.BLANC	200	100	30	2,5	Vrac gencodé	10
542330	3479045423308	Z.BLANC	240	120	40	2,5	Vrac gencodé	10
542340	3479045423407	Z.BLANC	280	140	50	2,5	Vrac gencodé	10
0280403	3308182804032	Z.BLANC	200	100	30	2,5		50
0280503	3308182805039	Z.BLANC	240	120	40	2,5		30
0280903	3308182809037	Z.BLANC	280	140	50	2,5		20

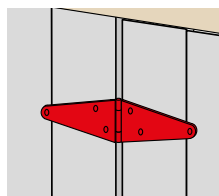

Charnière double axe composite

Code	Gencod		L	I	Ep.	Type packaging	
757970	3026727579701		300	50	2	Vrac gencodé	10
757971	3026727579718		400	50	2	Vrac gencodé	10
757870	3026727578704	Z.BLANC	300	50	2	Vrac gencodé	10
757871	3026727578711	Z.BLANC	400	50	2	Vrac gencodé	10

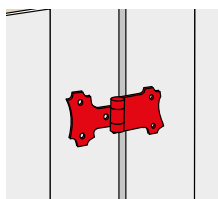
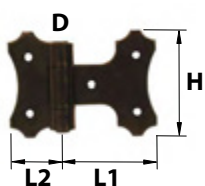

Charnière intermédiaire

Code	Gencod		D	L1	L2	H	Ep.	Type packaging	
0637801	3308186378010		14	83	47	95	4	Vrac gencodé	10

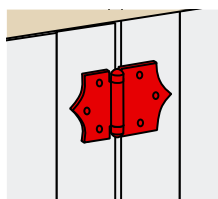
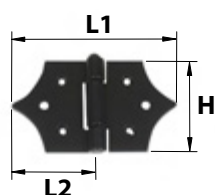

Charnière décorative

Code	Gencod		L1	L2	H	Ep.	Type packaging	
0504701	3308185047016		126	63	74	4	Vrac gencodé	10
0504703	3308185047030	Z.BLANC	126	63	74	4	Vrac gencodé	10
0241401	3308182414019		126	63	74	4		20
0241603	3308182416037	Z.BLANC	126	63	74	4		20
0241803	3308182418031	Z.BLANC	170	85	74	4		20

Gonds à sceller

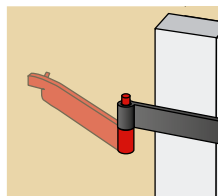
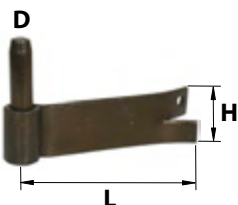

Gond à sceller simple

Code	Gencod		D	L	H	Ep.	Type packaging	
0774801	3308180038040		14	120	35	4	Vrac gencodé	10
0774803	3308180029901	Z.BLANC	14	120	35	4	Vrac gencodé	10

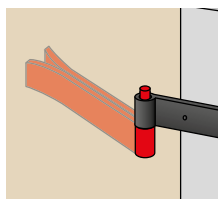
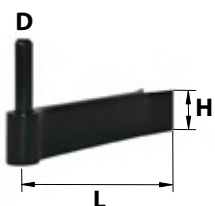

Gond à sceller renforcé

Code	Gencod		D	L	H	Ep.	Type packaging	
0807701	3308180037883		14	130	35	4	Vrac gencodé	10
579014	3479045790141		14	150	35	4	Vrac gencodé	10
0807703	3308180037890	Z.BLANC	14	130	35	4	Vrac gencodé	10
579013	3479045790134	Z.BLANC	14	150	35	4	Vrac gencodé	10
0956701	3308189567015		14	173	40	5	Vrac gencodé	10
735816	3026727358160	Z.BLANC	16	110	35	4	Vrac gencodé	5
0804801	3308180037913		16	130	40	5	Vrac gencodé	10
0525601	3308180038866		16	173	40	5	Vrac gencodé	10
0241301	3308182413012		14	130	35	4		30
0942501	3308189425018		16	130	40	5		30
0418301	3308184183012		16	173	40	5		10

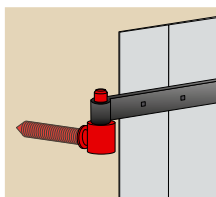
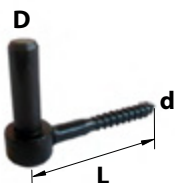

Gond à visser tirefond

Code	Gencod		D	L	d	Type packaging	
0387201	3308183872016		14	90	10	Vrac gencodé	10
0875201	3308188752016		16	90	10	Vrac gencodé	10
0387203	3308183872030	Z.BLANC	14	90	10	Vrac gencodé	10
0875203	3308188752030	Z.BLANC	16	90	10	Vrac gencodé	10
0237901	3308182379011		14	90	10		50
0418601	3308184186013		16	90	10		50
0427001	3308184270019		16	90	10		30

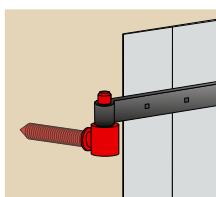
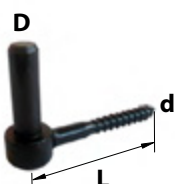

Gond à visser tirefond haut

Code	Gencod		D	L	d	Type packaging	
0350306	3308183503064	DP	14	90	10	Vrac gencodé	10

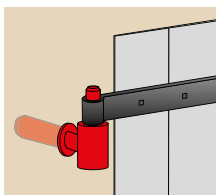

Gond à visser + cheville métal

Code	Gencod		D	L	d	Type packaging	
579152	3479045791520		14	60	M10	Vrac gencodé	5
579161	3479045791612		16	85	M10	Vrac gencodé	5
579151	3479045791513	Z.BLANC	14	60	M10	Vrac gencodé	5
579160	3479045791605	Z.BLANC	16	85	M10	Vrac gencodé	5
0237701	3308182377017		14	60	M10		30

Utiliser le gabarit de perçage (Réf. 0109503 P.163) pour faciliter la pose de votre gond.

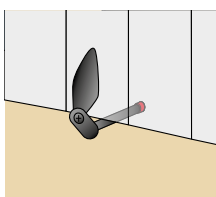

Cheville 4 segments (x2)

Code	Gencod		D	L	d	Type packaging	
0423000	3308184230006	Z.BLANC	10	60	M10	Brochable gencodé	1

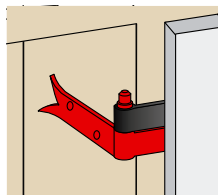
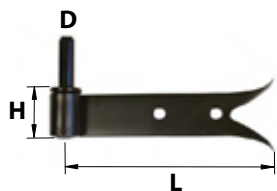

Gond à plaquer bout queue de carpe axe amovible

Code	Gencod		D	L	H	Ep.	Type packaging	
0096401	3308180041293		14	160	35	4	Vrac gencodé	1
739815	3026727398159	Z.BLANC	14	128	30	4	Vrac gencodé	5

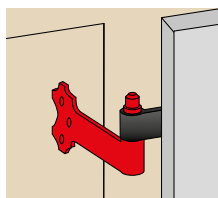
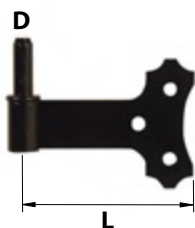

Gond à plaquer axe amovible

Code	Gencod		D	L	Ep.	Type packaging	
0524601	3308185246013		14	125	4	Vrac gencodé	1

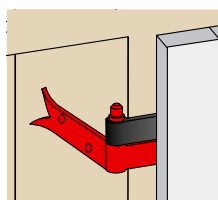
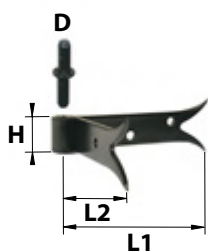

Gond d'angle bout queue de carpe axe amovible

Code	Gencod		D	L1	L2	I	Ep.	Type packaging	
0805401	3308180038637		14	160	130	35	5	Vrac gencodé	1

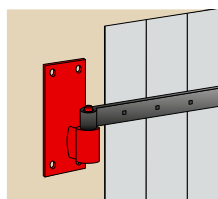
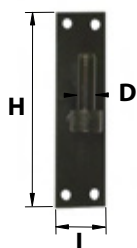

Gond sur platine bout droit

Code	Gencod		D	H	I	Ep.	Type packaging	
0526101	3308185261016		14	120	40	3	Vrac gencodé	5
179302	3221681793020		14	180	40	3	Vrac gencodé	5
0526106	3308185261061	DP	14	120	40	3	Vrac gencodé	5
0526103	3308185261030	Z.BLANC	14	120	40	3	Vrac gencodé	5
179301	3221681793013	Z.BLANC	14	180	40	3	Vrac gencodé	5
179320	3221681793204	Z.BLANC	16	180	40	3	Vrac gencodé	5
0942401	3308189424011		16	120	40	3		20

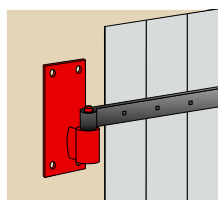
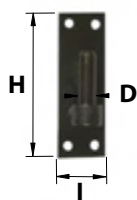

Gond sur platine courte bout droit

Code	Gencod		D	H	I	Ep.	Type packaging	
0526201	3308185262013		16	120	40	3	Vrac gencodé	5
0526203	3308185262037	Z.BLANC	16	120	40	3	Vrac gencodé	5
0257301	3308182573013		14	120	40	3		20

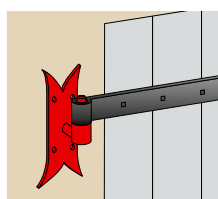
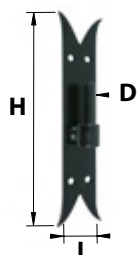

Gond sur platine bout queue de carpe

Code	Gencod		D	H	I	Ep.	Type packaging	
0994301	3308189943017		14	220	40	3	Vrac gencodé	5
0994401	3308189944014		16	220	40	3	Vrac gencodé	5
0994306	3308189943062	DP	14	220	40	3	Vrac gencodé	5
0994302	3308189943024	Z.BLANC	14	220	40	3	Vrac gencodé	5
0242201	3308182422014		14	220	40	3		10

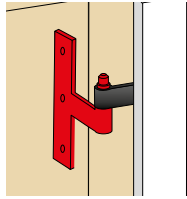
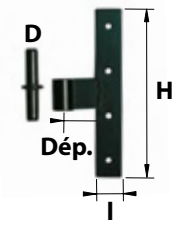

Gond sur té bout droit - Axe amovible

Code	Gencod		D	H	I	Ep.	Déport	Type packaging	
579405	3479045794057		14	190	30	5	35	Vrac gencodé	5

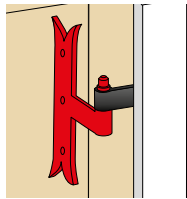
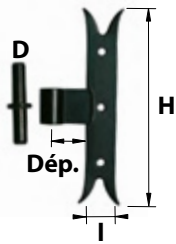

Gond sur té bout queue de carpe - Axe amovible

Code	Gencod		D	H	I	Ep.	Déport	Type packaging	
579401	3479045794019		14	190	30	5	35	Vrac gencodé	5
0964501	3308189645010		14	235	35	4	70	Vrac gencodé	5

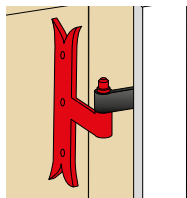
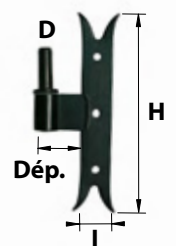

Gond sur té bout queue de carpe

Code	Gencod		D	H	I	Ep.	Déport	Type packaging	
Modèle Droite									
0288101	3308182881019		14	235	35	4	70		10
Modèle Gauche									
0288201	3308182882016		14	235	35	4	70		10

Modèle gauche

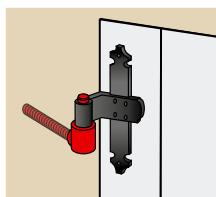
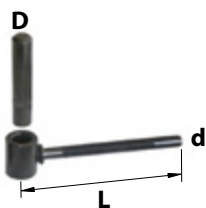

Gond à scellement chimique

Code	Gencod		D	L	d	Type packaging	
0904104	3308189041041		14	85	M10	Vrac gencodé	5
0904204	3308189042048		16	85	M10	Vrac gencodé	5
0904304	3308189043045		14	130	M10	Vrac gencodé	5
0904404	3308189044042		16	130	M10	Vrac gencodé	5
0904103	3308189041034	Z.BLANC	14	85	M10	Vrac gencodé	5
0904303	3308189043038	Z.BLANC	14	130	M10	Vrac gencodé	5
0904403	3308189044035	Z.BLANC	16	130	M10	Vrac gencodé	5
0260801	3308182608012		14	85	M10		30
0241901	3308182419014		14	130	M10		30
0418404	3308184184040		16	130	M10		30

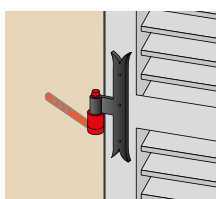
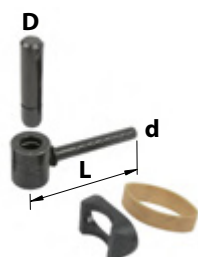

Polygond à clips renforcé fer à béton

Code	Gencod		D	L	d	Type packaging	
0980001	3308189800013		14	70	M10	Vrac gencodé	5
0980101	3308189801010		14	115	M10	Vrac gencodé	5

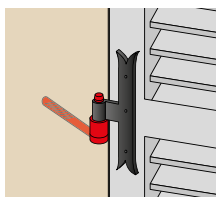

Polygond à clips

Code	Gencod		D	L	d	Type packaging	
0273901	3308182739013		14	70	M10	Vrac gencodé	5
0274001	3308182740019		16	70	M10	Vrac gencodé	5
0980301	3308189803014		14	130	M10	Vrac gencodé	5
0980401	3308189804011		16	130	M10	Vrac gencodé	5

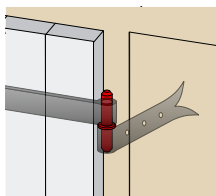
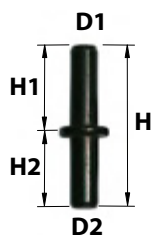

Axe de gond amovible

Code	Gencod		D1	D2	H	H1	H2	Type packaging	
0221904	3308182219041		14	14	80	42	35	Vrac gencodé	10
0900901	3308189009010		14	16	84	35	45	Vrac gencodé	10

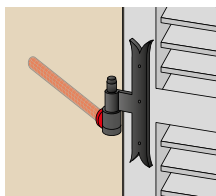
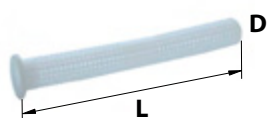

Tamis composite (x4)

Code	Gencod		D	L	Type packaging	
0456000	3308184560004		16	80	Vrac gencodé	5
0455900	3308184559008		16	130	Vrac gencodé	5

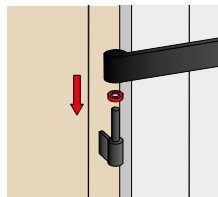
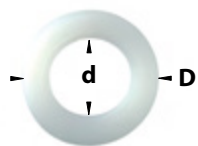

Rondelle composite (x10)

Code	Gencod		d	D	Ep.	Type packaging		
0952000	3308189520003		<input type="text"/>	14	25	3	Brochable gencodé	1
0952100	3308189521000		<input type="text"/>	16	27	3	Brochable gencodé	1
0418100	3308184181001		<input type="text"/>	14	25	3		30

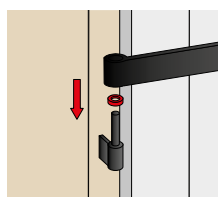
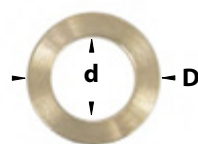

Rondelle laiton (x4)

Code	Gencod		d	D	Ep.	Type packaging		
0953900	3308189539005	LAITON	<input type="text"/>	14	25	3	Brochable gencodé	1
0954000	3308189540001	LAITON	<input type="text"/>	16	27	3	Brochable gencodé	1

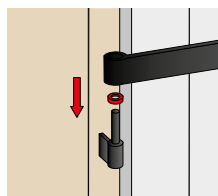
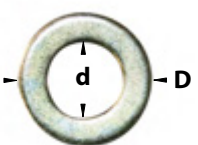

Rondelle acier (x4)

Code	Gencod		d	D	Ep.	Type packaging		
0953703	3308189537032	Z.BLANC	<input type="text"/>	14	25	3	Brochable gencodé	1
0953803	3308189538039	Z.BLANC	<input type="text"/>	16	27	3	Brochable gencodé	1

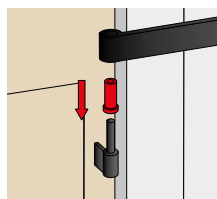

Convertisseur gond

Code	Gencod		d	D	L	Type packaging	
x2							
0953600	3308189536004		12	14	40,5	Brochable gencodé	1
0953500	3308189535007		14	16	40,5	Brochable gencodé	1
x4							
0418000	3308184180004		14	16	40,5		15

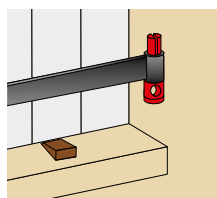

Gabarit de perçage pour gond à scellement chimique

Code	Gencod		Type packaging	
0963400	3308189634007		Brochable gencodé	1

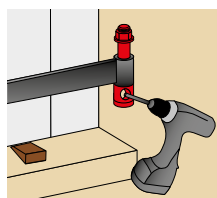

Gabarit de perçage acier pour gond à scellement chimique

Code	Gencod		Type packaging	
0109503	3308181095035	Z.BLANC	Brochable gencodé	1



Bague de propreté pour gond

Code	Gencod		Type packaging	
0960000	3308189600002		Sachet gencodé	5
0959900	3308189599009		Sachet gencodé	5



La mise en œuvre des fermetures est encadrée par le DTU 34-4, s'y référer pour éviter tout danger.

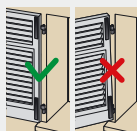

Bien s'assurer que le vantail soit monté plaqué et serré sur la façade.



En cas de vent, fermer les volets.



Pour les volets de grandes tailles, utiliser uniquement les arrêts adaptés



Conseils de pose P.133



Plus d'infos sur www.afbat.com

Tourniquet marseillais à vis bois *

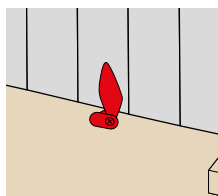
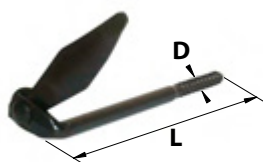

Code	Gencod		D	L	Type packaging	
0281201	3308182812013		10	110	Vrac gencodé	5
0222901	3308182229019		10	130	Vrac gencodé	5
0281301	3308182813010		10	180	Vrac gencodé	5
0417501	3308184175017		10	250	Vrac gencodé	1
0281203	3308182812037	Z.BLANC	10	110	Vrac gencodé	5
0222903	3308182229033	Z.BLANC	10	130	Vrac gencodé	5
0281303	3308182813034	Z.BLANC	10	180	Vrac gencodé	5
0249001	3308182490013		10	110		50
0426701	3308184267019		10	180		20
0425901	3308184259014		10	130		30
0426701	3308184267019		10	180		20
0426001	3308184260010		10	110		30

Tourniquet marseillais à vis + cheville *

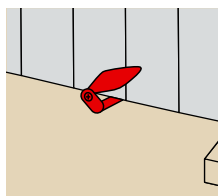

Code	Gencod		D	L	Type packaging	
0442304	3308184423040		8	115	Vrac gencodé	5
0442303	3308184423033	Z.BLANC	10	115	Vrac gencodé	5
0249301	3308182493014		8	115		30

Tourniquet marseillais sur platine à visser *

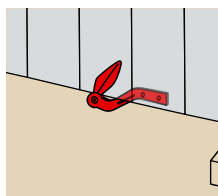
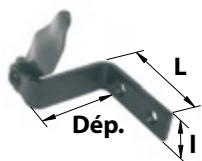

Code	Gencod		L	I	Ep.	Déport	Type packaging	
0238001	3308182380017		50	20	3,5	47	Vrac gencodé	5
0238003	3308182380031	Z.BLANC	50	20	3,5	47	Vrac gencodé	5

Arrêts de volet sur platine

(*)



La mise en œuvre des fermetures est encadrée par le DTU 34-4, s'y référer pour éviter tout danger.

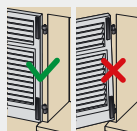

Bien s'assurer que le vantail soit monté plaqué et serré sur la façade.



En cas de vent, fermer les volets.



Pour les volets de grandes tailles, utiliser uniquement les arrêts adaptés



Conseils de pose P.133



Plus d'infos sur www.afbat.com



Dép.

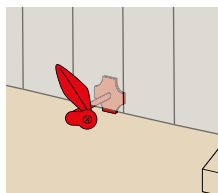

Tourniquet marseillais sur platine à visser *

Code	Gencod		Déport	Type packaging	
520350	3479045203504		40	Vrac gencodé	5
520355	3479045203559		70	Vrac gencodé	5

Arrêts de volet à sceller

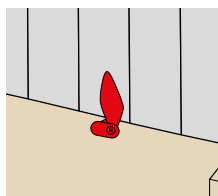
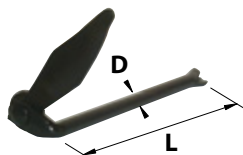

Tourniquet marseillais à sceller *

Code	Gencod		D	L	Type packaging	
0804601	3308188046016		10	130	Vrac gencodé	5
0804701	3308188047013		10	175	Vrac gencodé	5
0804603	3308180038163	Z.BLANC	10	130	Vrac gencodé	5
0804703	3308180038712	Z.BLANC	10	175	Vrac gencodé	5

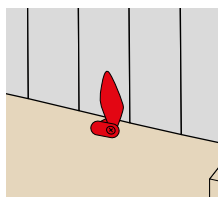
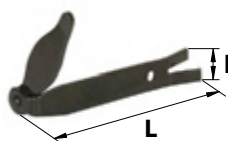

Tourniquet marseillais plat à sceller *

Code	Gencod		L	I	Ep.	Type packaging	
0248601	3308182486016		125	20	3,5		30



La mise en œuvre des fermetures est encadrée par le DTU 34-4, s'y référer pour éviter tout danger.

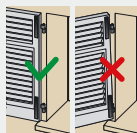

Bien s'assurer que le vantail soit monté plaqué et serré sur la façade.



En cas de vent, fermer les volets.



Pour les volets de grandes tailles, utiliser uniquement les arrêts adaptés



Conseils de pose P.133



Plus d'infos sur www.afbat.com

Arrêt tête bergère à visser *

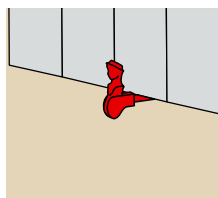
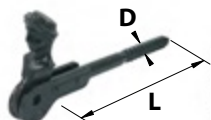

Code	Gencod		D	L	Type packaging	
0724001	3308187240019		10	115	Vrac gencodé	5
0724701	3308187247018		10	155	Vrac gencodé	5
0249501	3308182495018		10	115		50
0259801	3308182598016		10	155		20

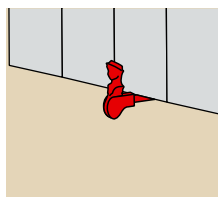
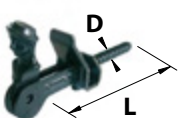

Arrêt tête bergère à visser + butée *

Code	Gencod		D	L	Type packaging	
0724901	3308187249012		10	115	Vrac gencodé	5

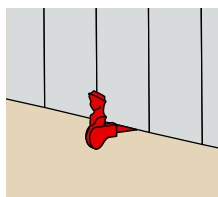

Arrêt tête bergère sur platine à visser *

Code	Gencod		Déport	Type packaging	
0900701	3308189007016		35	Vrac gencodé	5

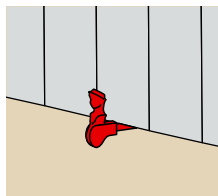
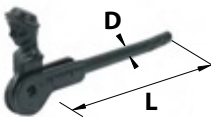

Arrêt tête bergère à sceller *

Code	Gencod		D	L	Type packaging	
0723901	3308187239013		10	135	Vrac gencodé	5

Butées d'arrêts de volet

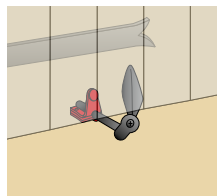
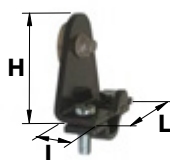

Butée universelle pour tourniquet marseillais

Code	Gencod		L	I	H	Ep.	Type packaging	
Sachet 2 unités								
0956501	3308189565011		41	17,5	41	2,5	Brochable gencodé	2
Sachet unitaire								
0198704	3308181987040		38	17,5	39	2,5	Vrac gencodé	1
0198703	3308180038873	Z.BLANC	38	17,5	39	2,5	Vrac gencodé	1
0432304	3308184323043		41	17,5	41	2,5		50

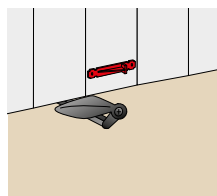

Protecteur de volet composite (x2)

Code	Gencod		L	I	H	Type packaging	
0953000	3308189530002		70	15	12	Brochable gencodé	1

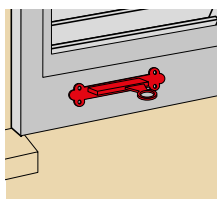

Arrêt de volet à ressort autobloquant

Code	Gencod		L	I	H	Ep.	Type packaging		
0954801	3308189548014		148	38	50	2	Brochable gencodé		1
0941501	3308189415019		148	38	50	2			10



La mise en œuvre des fermetures est encadrée par le DTU 34-4, s'y référer pour éviter tout danger.

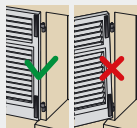

Bien s'assurer que le vantail soit monté plaqué et serré sur la façade.



En cas de vent, fermer les volets.



Pour les volets de grandes tailles, utiliser uniquement les arrêts adaptés



Conseils de pose P.133



Plus d'infos sur www.afbat.com

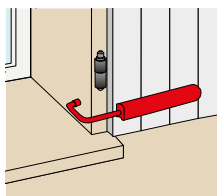
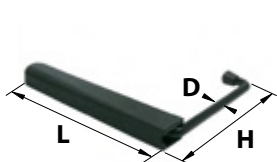

Arrêt de volet Verouilvolet (x2)

Code	Gencod		D	L	H	Type packaging		
0952400	3308189524001		12	250	135	Brochable gencodé		1
0958500	3308189585002		12	250	135	Brochable gencodé		1



La mise en œuvre des fermetures est encadrée par le DTU 34-4, s'y référer pour éviter tout danger.



Surface maximum 1 m² par vantail.

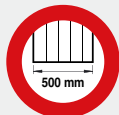

Largeur maximum du volet : 500 mm.



Ne pas utiliser en zone venteuse.



En cas de vent, fermer les volets.



Utiliser tous les trous de fixation prévus à cet effet (5) pour fixer la pièce.



Vérifier le serrage régulièrement.



Conseils de pose P.133



Plus d'infos sur www.afbat.com

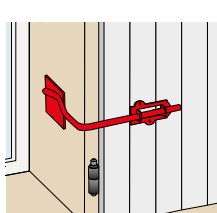
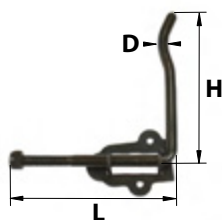

Arrêt de volet à poignée (x2)

Code	Gencod		D	L	H	Type packaging		
0956704	3308189567046		12	167	174	Brochable gencodé		1
0956626	3308189566261		12	167	174	Brochable gencodé		1
0932601	3308189326018		12	167	174			4



La mise en œuvre des fermetures est encadrée par le DTU 34-4, s'y référer pour éviter tout danger.



Surface maximum 1 m² par vantail.



Largeur maximum du volet : 500 mm.



Ne pas utiliser en zone venteuse.



En cas de vent, fermer les volets.



Utiliser tous les trous de fixation prévus à cet effet (2+2) pour fixer la pièce.



Vérifier le serrage régulièrement.



Conseils de pose P.133



Plus d'infos sur www.afbat.com

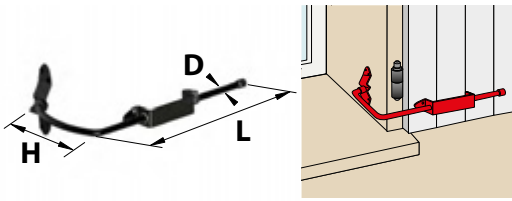

Arrêt de volet Bloc Boy

Code	Gencod		D	L	H	Type packaging	
0994800	3308189948005		14	414	188	Brochable gencodé	1
0994900	3308189949002		14	414	188	Brochable gencodé	1

La mise en œuvre des fermetures est encadrée par le DTU 34-4, s'y référer pour éviter tout danger.

Surface maximum 1,5 m² par vantail.

Poids maximum 20 kg par vantail

Ne pas utiliser en zone venteuse.

En cas de vent, fermer les volets.

Utiliser tous les trous de fixation prévus à cet effet (4+4) pour fixer la pièce.

Vérifier le serrage régulièrement.

Conseils de pose P.133

Plus d'infos sur www.afbat.com

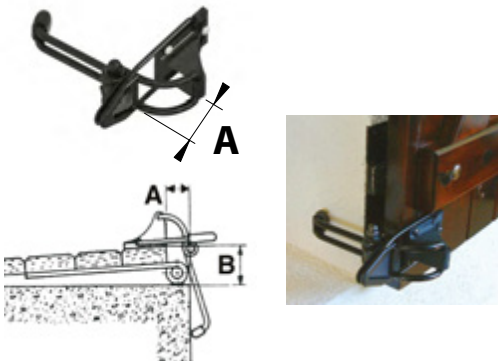

Arrêt BlocVolet

Code	Gencod		A	B	Type packaging	
152060	3332061520607		<ou= 3 cm	<ou= 9 cm	Brochable gencodé	1

La mise en œuvre des fermetures est encadrée par le DTU 34-4, s'y référer pour éviter tout danger.

Surface maximum 1 m² par vantail.

Poids maximum 20 kg par vantail

Ne pas utiliser en zone venteuse.

En cas de vent, fermer les volets.

Utiliser tous les trous de fixation prévus à cet effet (3) pour fixer la pièce.

Vérifier le serrage régulièrement.

Conseils de pose P.133

Plus d'infos sur www.afbat.com

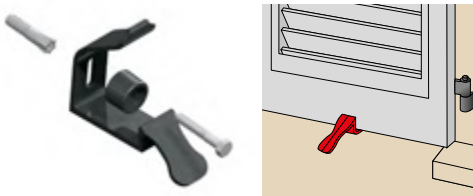

Arrêt StopVolet (x 2)

Code	Gencod		Type packaging	
Epaisseur de volet de 20 à 35 mm				
151050	3332061510509		Vrac gencodé	10
621430	3332061511308		Vrac gencodé	10

La mise en œuvre des fermetures est encadrée par le DTU 34-4, s'y référer pour éviter tout danger.

Bien s'assurer que le vantail soit monté plaqué et serré sur la façade.

En cas de vent, fermer les volets.

Pour les volets de grandes tailles, utiliser uniquement les arrêts adaptés

Conseils de pose P.133

Plus d'infos sur www.afbat.com

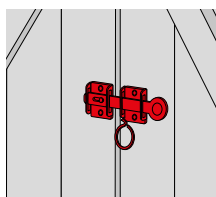
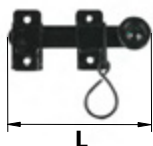

Fermeture de volet + support

Code	Gencod		L	Type packaging	
0273201	3308182732014		130	Vrac gencodé	5
0941901	3308189419017		130		20

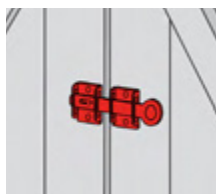

Poignée fléau à blocage + support

Code	Gencod		L	Type packaging	
529202	3479045292027		160	Vrac gencodé	5
529183	3479045291839	Z.BLANC	160	Vrac gencodé	5
9529203	3479045292034		190	Vrac gencodé	5
529181	3479045291815	Z.BLANC	190	Vrac gencodé	5

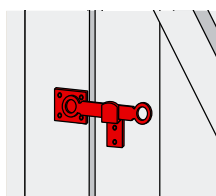
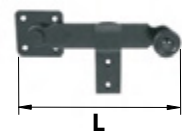

Poignée fléau + support

Code	Gencod		L	Type packaging	
0812701	3308188127012		140	Vrac gencodé	10
0812901	3308188129016		160	Vrac gencodé	10
0813001	3308188130012		190	Vrac gencodé	10
0812703	3308180038552	Z.BLANC	140	Vrac gencodé	10
0812903	3308180038569	Z.BLANC	160	Vrac gencodé	10
0813003	3308180038576	Z.BLANC	190	Vrac gencodé	10
0941801	3308189418010		140		20
0246302	3308182463024	Z.BLANC	140		20
0246402	3308182464021	Z.BLANC	190		20

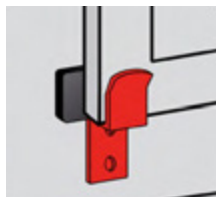
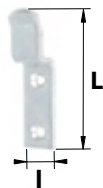

Agrafe volet nord coudée

Code	Gencod		L	I	Ep.	Type packaging	
6104009	3221686104005	Z.BLANC	75	18	3	Vrac gencodé	5

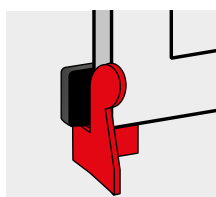

Modèle droite

Agrafe picarde coudée

Code	Gencod		L	I	Ep.	Type packaging	
Modèle droite							
6106134	3221686106139	Z.BLANC	35	18	3	Vrac gencodé	5
Modèle gauche							
6106234	3221686106238	Z.BLANC	35	18	3	Vrac gencodé	5

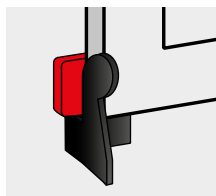
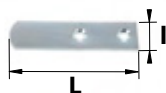

Panneton droit

Code	Gencod		L	I	Ep.	Type packaging	
6103075	3221686103077	Z.BLANC	75	18	3	Vrac gencodé	5

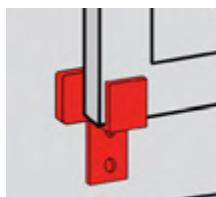

Panneton + agrafe

Code	Gencod		Type packaging	
Panneton + agrafe nord coudée (x4)				
0544175	3221680544173		Vrac gencodé	1
0144175	3221680144175	Z.BLANC	Vrac gencodé	1
Panneton + agrafe picarde (2 droite + 2 gauche)				
0953302	3308189533027	Z.BLANC	Brochable gencodé	1

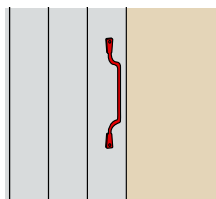
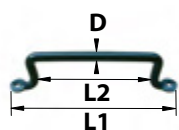

Poignée fil à pattes

Code	Gencod		D	L1	L2	Type packaging	
9158085	3221689158081		8	140	85	Vrac gencodé	10
0357804	3308183578048		8	165	95	Vrac gencodé	10
0502104	3308185021047		10	160	105	Vrac gencodé	10
7158085	3221687158083	Z.BLANC	8	140	85	Vrac gencodé	10
6158100	3221686158107	Z.BLANC	8	165	95	Vrac gencodé	10
0502102	3308185021023	Z.BLANC	10	160	105	Vrac gencodé	10
0258201	3308182582015		8	165	95		50
0258202	3308182582022	Z.BLANC	8	165	95		50

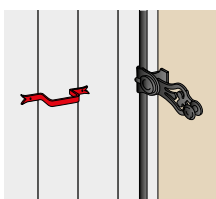
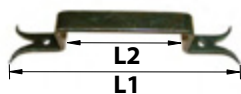

Poignée à pattes queue de carpe

Code	Gencod		L1	L2	Type packaging	
9115085	3221689115084		175	85	Vrac gencodé	10

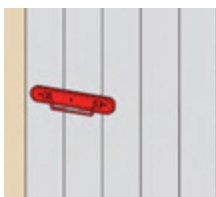

Poignée sur platine bouts ronds

Code	Gencod		L	Type packaging	
8149014	3221688149141		140	Vrac gencodé	10
8149016	3221688149165		160	Vrac gencodé	10
8149019	3221688149196		190	Vrac gencodé	10
6149014	3221686149143	Z.BLANC	140	Vrac gencodé	10
6149016	3221686149167	Z.BLANC	160	Vrac gencodé	10
6149019	3221686149198	Z.BLANC	190	Vrac gencodé	10

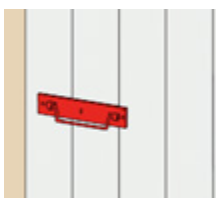

Poignée sur platine bouts carrés

Code	Gencod		L	Type packaging	
8150012	3221688150123		120	Vrac gencodé	10
8150014	3221688150147		140	Vrac gencodé	10
8150016	3221688150161		160	Vrac gencodé	10
8150019	3221688150192		190	Vrac gencodé	10
0491303	3308184913039	Z.BLANC	120	Vrac gencodé	10
0724103	3308187241030	Z.BLANC	140	Vrac gencodé	10
7150016	3221687150162	Z.BLANC	160	Vrac gencodé	10
7150019	3221687150193	Z.BLANC	190	Vrac gencodé	10
0246504	3308182465042		140		30
0246503	3308182465035	Z.BLANC	140		30

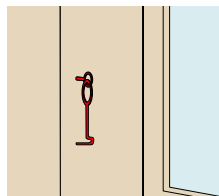
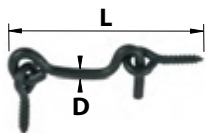

Crochet de contrevent + pitons

Code	Gencod		D	L	Type packaging	
8177005	3221688177007		4	50	Vrac gencodé	10
8177060	3221688177069		4	60	Vrac gencodé	10
8177080	3221688177083		4	80	Vrac gencodé	10
6177005	3221686177009	Z.BLANC	4	50	Vrac gencodé	10
6177060	3221686177061	Z.BLANC	4	60	Vrac gencodé	10
6177080	3221686177085	Z.BLANC	4	80	Vrac gencodé	10
8177100	3221688177106		5	100	Vrac gencodé	10
8177120	3221688177120		5	120	Vrac gencodé	10
6177100	3221686177108	Z.BLANC	5	100	Vrac gencodé	10
6177120	3221686177122	Z.BLANC	5	120	Vrac gencodé	10
8177140	3221688177144		6	140	Vrac gencodé	10
8177160	3221688177168		6	160	Vrac gencodé	10
8177180	3221688177182		6	180	Vrac gencodé	10
8177200	3221688177205		6	200	Vrac gencodé	10
6177140	3221686177146	Z.BLANC	6	140	Vrac gencodé	10
6177160	3221686177160	Z.BLANC	6	160	Vrac gencodé	10
6177180	3221686177184	Z.BLANC	6	180	Vrac gencodé	10
6177200	3221686177207	Z.BLANC	6	200	Vrac gencodé	10
0494804	3308184948048		8	300	Vrac gencodé	10
0494904	3308184949045		8	400	Vrac gencodé	10
0495004	3308184950041		8	500	Vrac gencodé	10
0494802	3308184948024	Z.BLANC	8	300	Vrac gencodé	10
0494902	3308184949021	Z.BLANC	8	400	Vrac gencodé	10
0495002	3308184950027	Z.BLANC	8	500	Vrac gencodé	10
0245402	3308182454022	Z.BLANC	4	50		100
0245502	3308182455029	Z.BLANC	4	80		100
0245602	3308182456026	Z.BLANC	5	100		100
0245702	3308182457023	Z.BLANC	5	120		50
0245802	3308182458020	Z.BLANC	6	140		50
0245902	3308182459027	Z.BLANC	6	160		50
0246002	3308182460023	Z.BLANC	6	180		50
0246102	3308182461020	Z.BLANC	6	200		50
Sachet de 2 unités						
672305	3026726723051	Z.BLANC	8	60	Vrac gencodé	
672308	3026726723082	Z.BLANC	8	80	Vrac gencodé	
672310	3026726723105	Z.BLANC	8	100	Vrac gencodé	
672314	3026726723143	Z.BLANC	8	140	Vrac gencodé	
672316	3026726723167	Z.BLANC	8	160	Vrac gencodé	

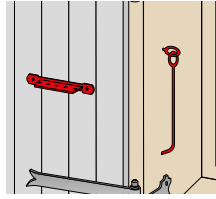

Crochet + crémaillère à poignée

Code	Gencod		D	L	Type packaging	
0491104	3308180038897		8	300	Vrac gencodé	10
503496	3479045034962		8	350	Vrac gencodé	10
0491004	3308180038910		8	400	Vrac gencodé	10
0812404	3308180038521		8	500	Vrac gencodé	10
503500	3479045035006		8	600	Vrac gencodé	10
0491103	3308184911035	Z.BLANC	8	300	Vrac gencodé	10
503476	3479045034764	Z.BLANC	8	350	Vrac gencodé	10
0491003	3308184910038	Z.BLANC	8	400	Vrac gencodé	10
0812403	3308180038514	Z.BLANC	8	500	Vrac gencodé	10
503480	3479045034801	Z.BLANC	8	600	Vrac gencodé	10
0464604	3308184646043		8	300		40
0465004	3308184650040		8	400		25

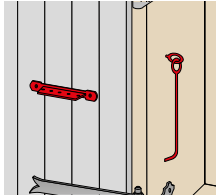

Crochet + crémaillère L

Code	Gencod		D	L	Type packaging	
0288002	3308182880029	Z.BLANC	8	300		20
0466102	3308184661022	Z.BLANC	8	400		20
0466202	3308184662029	Z.BLANC	8	500		20

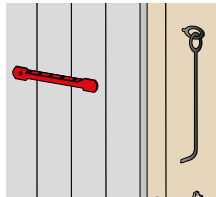
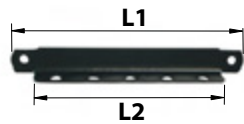

Crémaillère L

Code	Gencod		L1	L2	Ep.	Type packaging	
0362501	3308183625018		190	155	2	Vrac gencodé	1

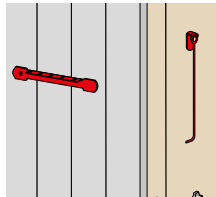
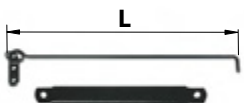

Crochet sur platine + crémaillère L

Code	Gencod		D	L	Type packaging	
0963001	3308189630016		8	300	Vrac gencodé	5
0963101	3308189631013		8	400	Vrac gencodé	5

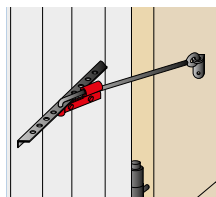

Verrou antisoulèvement pour crochet de volet

Code	Gencod		D	L	Type packaging	
0958200	3308189582001		10	97	Brochable gencodé	1

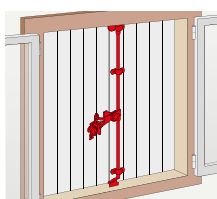
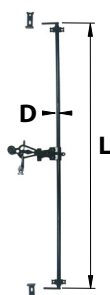
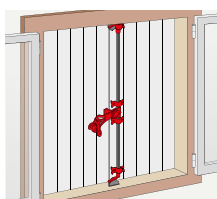
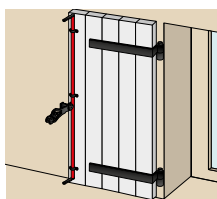
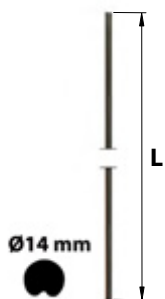
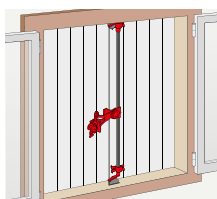
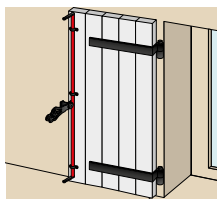
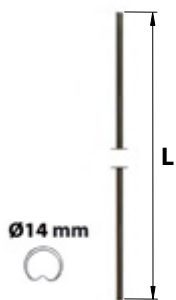

Tube rainuré pour espagnolette acier

Code	Gencod		D	L	Type packaging	
0262101	3308182621011		14	1270	Vrac gencodé	1
0706800	3308187068002		14	1570	Vrac gencodé	1

Accessoires espagnolette ronde rainurée

Code	Gencod		Type packaging	
1 Support antisoulèvement				
0954401	3308189544016		Brochable gencodé	1
2 Support standard				
0954301	3308189543019		Brochable gencodé	1
0941601	3308189416016			10

Composition

1 poignée + 1 boulon 2 crochets droits
 2 lacets rustiques + 1 lacet fil rond 1 support antisoulèvement 1 ou 1 support standard 2

Tringle rainurée pleine Provence

Code	Gencod		D	L	Type packaging	
0980501	3308189805018		14	1500	Vrac gencodé	1
0980601	3308189806015		14	2000	Vrac gencodé	1
0980701	3308189807012		14	2500	Vrac gencodé	1

Sachet d'accessoires Provence

Code	Gencod		Type packaging	
Crochets droits - Support de sécurité - Lacets rustiques - Dardennes coudées				
07PNC3B14	3700093126584		Vrac gencodé	10
Crochets droits - Support de sécurité - Lacets déportés - Dardennes coudées				
0981201	3700093126591		Vrac gencodé	10
Crochets droits - Support - Lacets rustiques - Dardennes coudées				
0983201	3700093126539		Vrac gencodé	10
Crochets droits - Support - Lacets déportés - Dardennes coudées				
0983301	3700093126546		Vrac gencodé	1

Kit complet espagnolette ronde pleine

Code	Gencod		D	L	Type packaging	
0703404	3308187034045		14	1500	Vrac gencodé	1
0703504	3308187035042		14	2400	Vrac gencodé	1

Composition

1 poignée + 1 boulon 3 lacets à patte rustique + 1 lacet fil rond
 1 tringle, 2 crochets soudés 1 support antisoulèvement
 2 butées

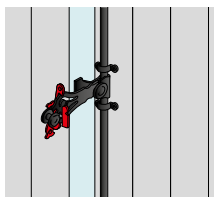

Support espagnolette antisoulèvement

Code	Gencod		Type packaging	
0957801	3308189578011		Brochable gencodé	1

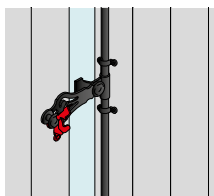

Support espagnolette verrou

Code	Gencod		Type packaging	
0957904	3308189579049		Brochable gencodé	1

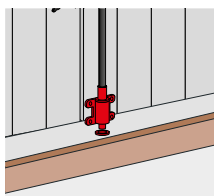

Modèle bas

Verrou espagnolette

Code	Gencod		Type packaging	
Modèle Bas				
0958300	3308189583008		Brochable gencodé	1
Modèle Haut				
0964800	3308189648004		Brochable gencodé	1

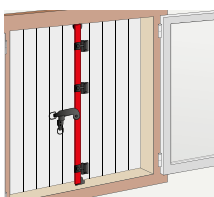

Tringle pour espagnolette plate acier

Code	Gencod		L	I	Ep.	Type packaging	
620651	3479046206511		1500	25	4	Vrac gencodé	1
620653	3479046206535		2500	25	4	Vrac gencodé	1

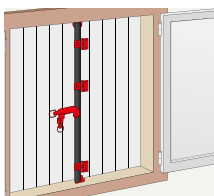

Accessoires espagnolette plate acier

Code	Gencod		Type packaging	
620632	3221686206327		Brochable gencodé	1

Composition
3 coulisseaux
1 support de loquet

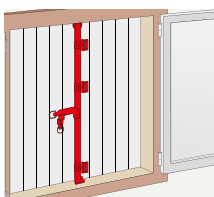

Kit complet espagnolette plate

Code	Gencod		L	I	Ep.	Type packaging	
0703204	3308187032041		1500	25	4	Vrac gencodé	1
0703304	3308187033048		2400	25	4	Vrac gencodé	1

Composition
1 tringle plate L1500 ou 2400 mm
1 butée haute + 1 butée basse
3 coulisseaux
1 support de loquet

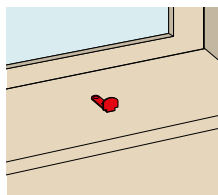
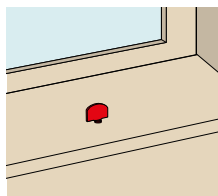
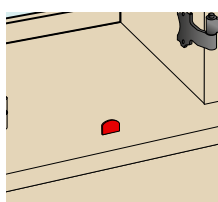
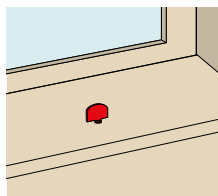
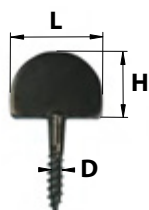

Butée droite à vis

Code	Gencod		D	L	H	Ep.	Type packaging	
9251001	3221689251010		6	57	25	3,5	Vrac gencodé	10
7251001	3221687251005	Z.BLANC	6	57	25	3,5	Vrac gencodé	10
0244301	3308182443019		6	57	25	3,5		100
x2								
0988001	3308189880015		6	57	25	3,5	Vrac gencodé	5
Butée droite à vis + à cheville (x2)								
0269401	3308182694015		6	57	25	3,5	Brochable gencodé	1

Butée coudée à vis

Code	Gencod		D	L	H	Ep.	Déport	Type packaging	
0544404	3308185444044		6	37	27	3	36	Vrac gencodé	10
0988201	3308189882019		6	37	27	3	36	Vrac gencodé	5
7351011	3221687351019	Z.BLANC	6	37	27	3	36	Vrac gencodé	10
0244101	3308182441015		6	37	27	3	36		100

Kit butée à vis 1 droite + 1 coudée + 2 chevilles

Code	Gencod		Type packaging	
538055	3221685380554		Brochable gencodé	10

Butée coudée ronde à visser

Code	Gencod		H	Ep.	Déport	Type packaging	
9351600	3221689351604		25	3	30	Vrac gencodé	10
7351600	3221687351606	Z.BLANC	25	3	30	Vrac gencodé	10

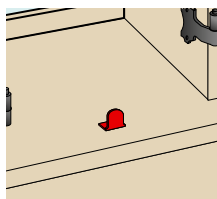
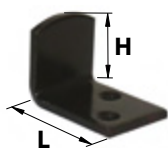

Butée coudée à visser

Code	Gencod		L	H	Ep.	Type packaging	
4239034	3221684139030		44	25	4	Vrac gencodé	10
7239034	3221687239034	Z.BLANC	44	25	4	Vrac gencodé	10

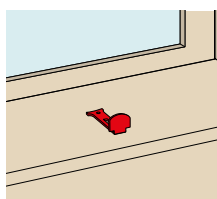
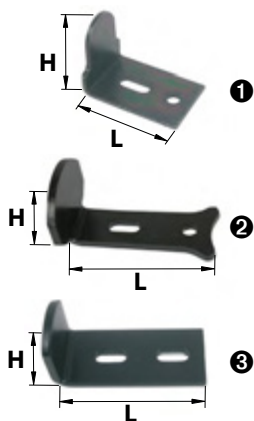

Butée coudée réglable à visser

Code	Gencod		L	H	Ep.	Type packaging		
1 trou rond + 1 trou oblong								
①	620099	3479046200991		47	35	2,5	Vrac gencodé	10
②	602040	3221686020404		63	35	3	Vrac gencodé	10
②	0942904	3308189429047		63	35	3		50
2 trous oblongs								
③	4172034	3221684172037		69	30	4	Vrac gencodé	10
③	7172034	3221687172034	Z.BLANC	69	30	4	Vrac gencodé	10

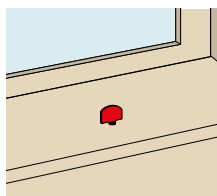

Butée droite à sceller

Code	Gencod		L	H	Ep.	Type packaging	
0408404	3308184084043		60	25	4	Vrac gencodé	10
0408403	3308184084036	Z.BLANC	60	25	4	Vrac gencodé	10

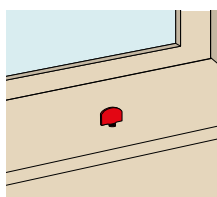

Butée coudée à sceller

Code	Gencod		H	Ep.	Déport	Type packaging	
9151011	3221689151013		25	3	32	Vrac gencodé	10

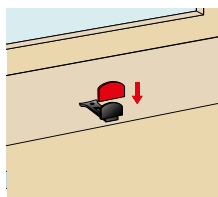
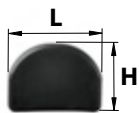

Protecteur tête de butée composite (x2)

Code	Gencod		L	H	Type packaging	
0952900	3308189529006		43	33	Brochable gencodé	1

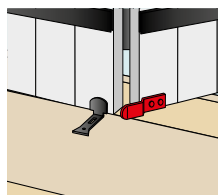
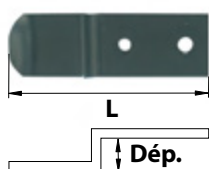

Crochet de rappel (x2)

Code	Gencod		L	Ep.	Déport	Type packaging	
0952604	3308189526043		70	2,5	10	Brochable gencodé	1
0261501	3308182615010		70	2,5	10		20

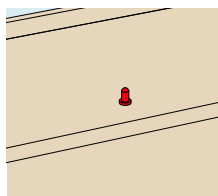

Goujon espagnolette

Code	Gencod		ØD	Ød	H	Type packaging	
Droit à visser							
0963701	3308189637015		10	7	65	Vrac gencodé	1
Droit à visser (x2) + chevilles (x2)							
0269601	3308182696019		10	7	65	Brochable gencodé	1
Goujon droit (x1) + coudé (x1) + chevilles (x2)							
620093	3221686200936		10	7	65	Brochable gencodé	1

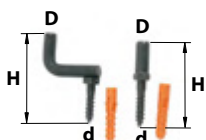



L'EXTÉRIEUR DE L'HABITAT

LE VOLET ALU & PVC

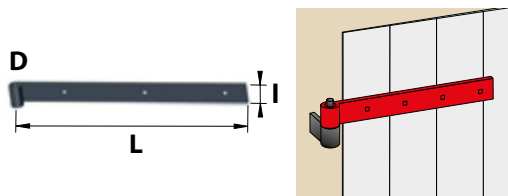

Penture aluminium bout droit

Code	Gencod		D	L	I	Ep.	Type packaging	
1401415	3308181401416		14	415	39	4	Vrac gencodé	4
1401560	3308181401560		14	560	39	4	Vrac gencodé	4

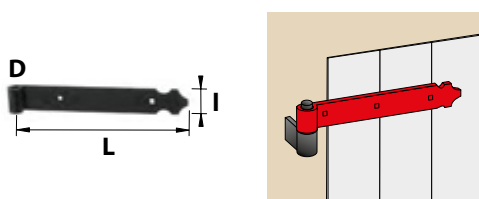

Penture aluminium bout feston

Code	Gencod		D	L	I	Ep.	Type packaging	
1403415	3308181403410		14	415	39	4	Vrac gencodé	4
1403560	3308181403564		14	560	39	4	Vrac gencodé	4

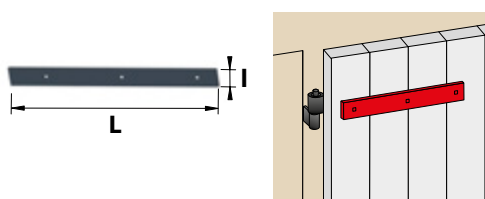

Contre-penture aluminium bout droit

Code	Gencod		L	I	Ep.	Type packaging	
1402355	3308181402352		355	39	3	Vrac gencodé	4
1402500	3308181402505		500	39	3	Vrac gencodé	4

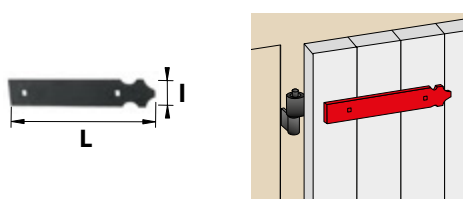

Contre-penture aluminium bout feston

Code	Gencod		L	I	Ep.	Type packaging	
1404370	3308181404370		370	39	2	Vrac gencodé	4
1404515	3308181404516		515	39	2	Vrac gencodé	4

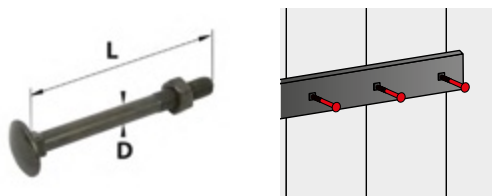

Boulon TRCC aluminium (x8)

Code	Gencod		D	L	Type packaging	
1405645	3221684056450		6	45	Brochable gencodé	1

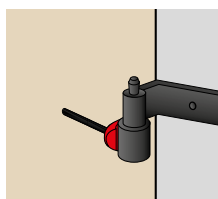

Bague de propreté pour gond

Code	Gencod		L	H	Type packaging	
0960000	3308189600002		47	13	Vrac gencodé	5
0959900	3308189599009		47	13	Vrac gencodé	5

Gonds

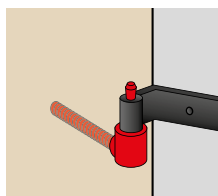
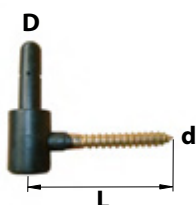

Gond à visser composite

Code	Gencod		D	d	L	Type packaging	
0214800	3308182148006		14	10	95	Vrac gencodé	1
0645000	3308186450006		14	10	95	Vrac gencodé	1

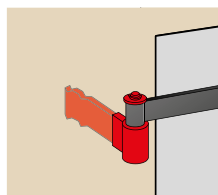
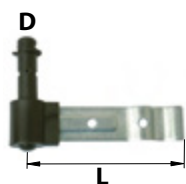

Gond à sceller composite

Code	Gencod		D	L	Type packaging	
0214600	3308182146002		14	115	Vrac gencodé	1
0591100	3308185911003		14	115	Vrac gencodé	1

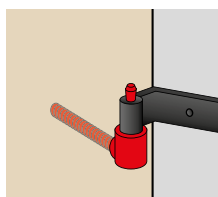
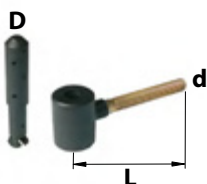

Gond à scellement chimique composite

Code	Gencod		D	d	L	Type packaging	
0215300	3308182153000		14	M10	135	Vrac gencodé	1
0661200	3308186612008		14	M10	135	Vrac gencodé	1

Arrêts de volets à visser



La mise en œuvre des fermetures est encadrée par le DTU 34-4, s'y référer pour éviter tout danger.

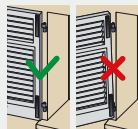

Bien s'assurer que le vantail soit monté plaqué et serré sur la façade.



En cas de vent, fermer les volets.



Pour les volets de grandes tailles, utiliser uniquement les arrêts adaptés



Conseils de pose P.133



Plus d'infos sur www.afbat.com

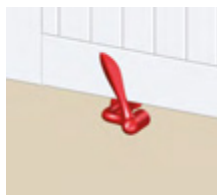
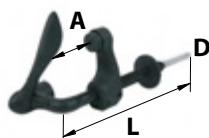

Tourniquet marseillais composite * Hélice à rouleau

Code	Gencod		D	L	A	Type packaging		
0997300	3308189973007		10	160	12/46	Vrac gencodé		1
0997400	3308189974004		10	160	12/46	Vrac gencodé		1

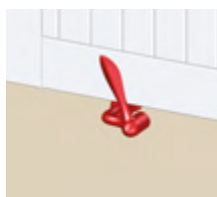
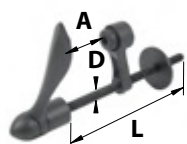

Tourniquet marseillais zamak * Hélice à rouleau

Code	Gencod		D	L	A	Type packaging		
1010600	3308180106008		10	165	12/60	Vrac gencodé		1
1010700	3308180107005		10	265	12/110	Vrac gencodé		1

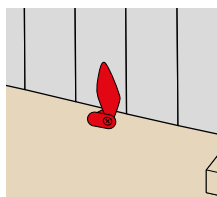
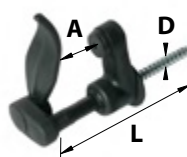

Tourniquet marseillais composite à visser S4000 *

Code	Gencod		D	L	A	Type packaging		
0951700	3308189517003		10	130	12/46	Vrac gencodé		5
0951900	3308189519007		10	200	12/116	Vrac gencodé		5
0951600	3308189516006		10	130	12/46	Vrac gencodé		5
0951800	3308189518000		10	200	12/116	Vrac gencodé		5
0951750	3308189517508		10	130	12/46			10

Arrêts tête de bergère à visser

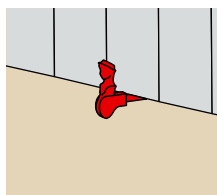
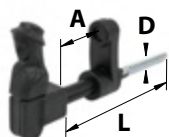

Arrêt tête bergère composite à visser S4000 *

Code	Gencod		D	L	A	Type packaging		
501320	3221685013209		10	200	22/65	Vrac gencodé		1
501315	3221685013155		10	200	22/65	Vrac gencodé		1

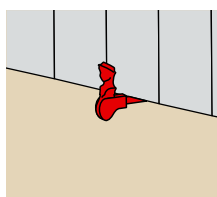
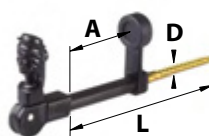

Arrêt tête bergère zamak à visser *

Code	Gencod		D	L	A	Type packaging		
0955206	3308189552066		10	150	40/70	Brochable gencodé		1
0954926	3308189549264		10	150	40/70	Brochable gencodé		1



La mise en œuvre des fermetures est encadrée par le DTU 34-4, s'y référer pour éviter tout danger.

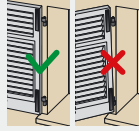

Bien s'assurer que le vantail soit monté plaqué et serré sur la façade.



En cas de vent, fermer les volets.



Pour les volets de grandes tailles, utiliser uniquement les arrêts adaptés



Conseils de pose P.133



Plus d'infos sur www.afbat.com

Arrêt composite automatique *

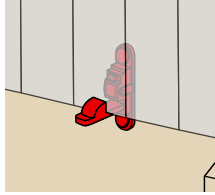

Code	Gencod		A	I	H	Type packaging	
0108600	3308181086002		6/36	32	110	Vrac gencodé	10
0108800	3308181088006		6/86	32	110	Vrac gencodé	10
0108700	3308181087009		6/36	32	110	Vrac gencodé	1
0108900	3308181089003		6/86	32	110	Vrac gencodé	1
0260000	3308182600009		6/36	32	110		20
0942100	3308189421003		6/86	32	110		10

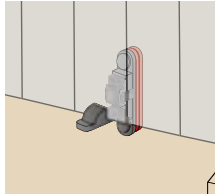

Cale arrêt composite automatique

Code	Gencod		I	H	Ep.	Type packaging	
0962200	3308189622004		36	116	10	Vrac gencodé	5
0962100	3308189621007		36	116	10	Vrac gencodé	5

Arrêt automatique aluminium *

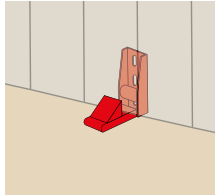

Code	Gencod		I	H	Type packaging	
Pour volet de 40 à 58 mm						
4631002	3221684631022		24,5	90	Vrac gencodé	1
4631001	3221684631008		24,5	90	Vrac gencodé	1

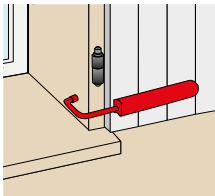
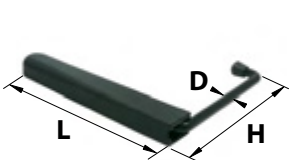

Arrêt de volet Veruilvolet (x2)

Code	Gencod		D	L	H	Type packaging	
0952400	3308189524001		12	250	135	Brochable gencodé	1
0958500	3308189585002		12	250	135	Brochable gencodé	1



La mise en œuvre des fermetures est encadrée par le DTU 34-4, s'y référer pour éviter tout danger.



Surface maximum 1 m² par vantail.



Largeur maximum du volet : 500 mm.



Ne pas utiliser en zone venteuse.



En cas de vent, fermer les volets.



Utiliser tous les trous de fixation prévus à cet effet (5) pour fixer la pièce.



Vérifier le serrage régulièrement.



Conseils de pose P.133



Plus d'infos sur www.afbat.com



La mise en œuvre des fermetures est encadrée par le DTU 34-4, s'y référer pour éviter tout danger.

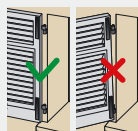

Bien s'assurer que le vantail soit monté plaqué et serré sur la façade.



En cas de vent, fermer les volets.



Pour les volets de grandes tailles, utiliser uniquement les arrêts adaptés



Conseils de pose P.133



Plus d'infos sur www.afbat.com

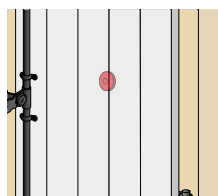
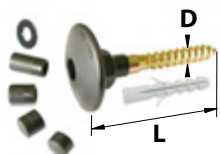

Butée murale composite à visser *

Code	Gencod		D	L	Type packaging	
0956100	3308189561006		10	75	Brochable gencodé	1

Crochets + crémaillères

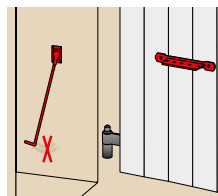
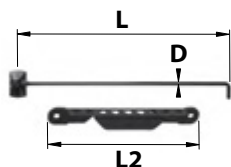

Crochet aluminium sur platine anti-choc + crémaillère à poignée

Code	Gencod		D	L	L2	Type packaging	
0956801	3308189568012		8	480	180	Brochable gencodé	1

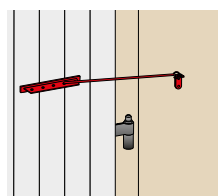
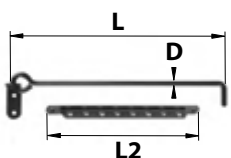

Crochet aluminium sur platine + crémaillère en T

Code	Gencod		D	L	L2	Type packaging	
0963201	3308189632010		8	300	180	Vrac gencodé	5
0963226	3308189632263		8	300	180	Vrac gencodé	5

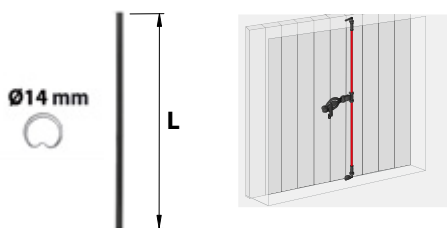

Tube espagnolette rainurée aluminium

Code	Gencod		D	L	Type packaging	
620500	3221686205009		14	1270	Vrac gencodé	1
620502	3221686205023		14	1570	Vrac gencodé	1
465627	3221684656278		14	1270	Vrac gencodé	1
465626	3221684656261		14	1570	Vrac gencodé	1



Accessoires espagnolette zamak rainurée

Code	Gencod		Type packaging	
0959800	3308189598002		Brochable gencodé	1

Composition

- 1 poignée sécurité intégrée
- 1 support
- 4 lacets
- 2 crochets

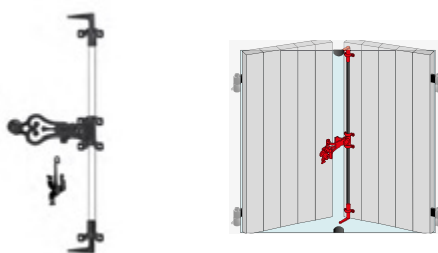

Accessoires espagnolette aluminium rainurée

Code	Gencod		Type packaging	
0954200	3308189542005		Brochable gencodé	1
0954100	3308189541008		Brochable gencodé	1

Composition

- 1 poignée
- 1 support antisoulèvement
- 4 lacets
- 2 crochets

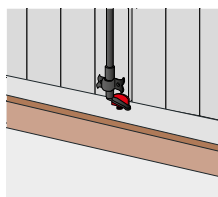

Butée à vis + tampon composite

Code	Gencod		D	L	I	Type packaging	
0961800	3308189618007		6,5	65	39	Brochable gencodé	1
0961700	3308189617000		6,5	65	39	Brochable gencodé	1

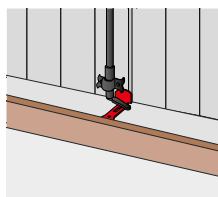
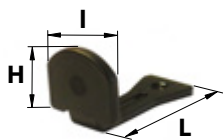

Butée coudée réglable à visser + tampon composite

Code	Gencod		L	I	H	Type packaging	
0962000	3308189620000		66	39	40	Brochable gencodé	1
0961900	3308189619004		66	39	40	Brochable gencodé	1
0941700	3308189417006		66	39	40		25



L'EXTÉRIEUR DE L'HABITAT

L'ISOLATION EXTÉRIEURE

A chaque produit son cas de figure

Afin de répondre de la meilleure façon à tous les types de pose, AFBAT® propose un large éventail de produits adaptés à des contraintes spécifiques.

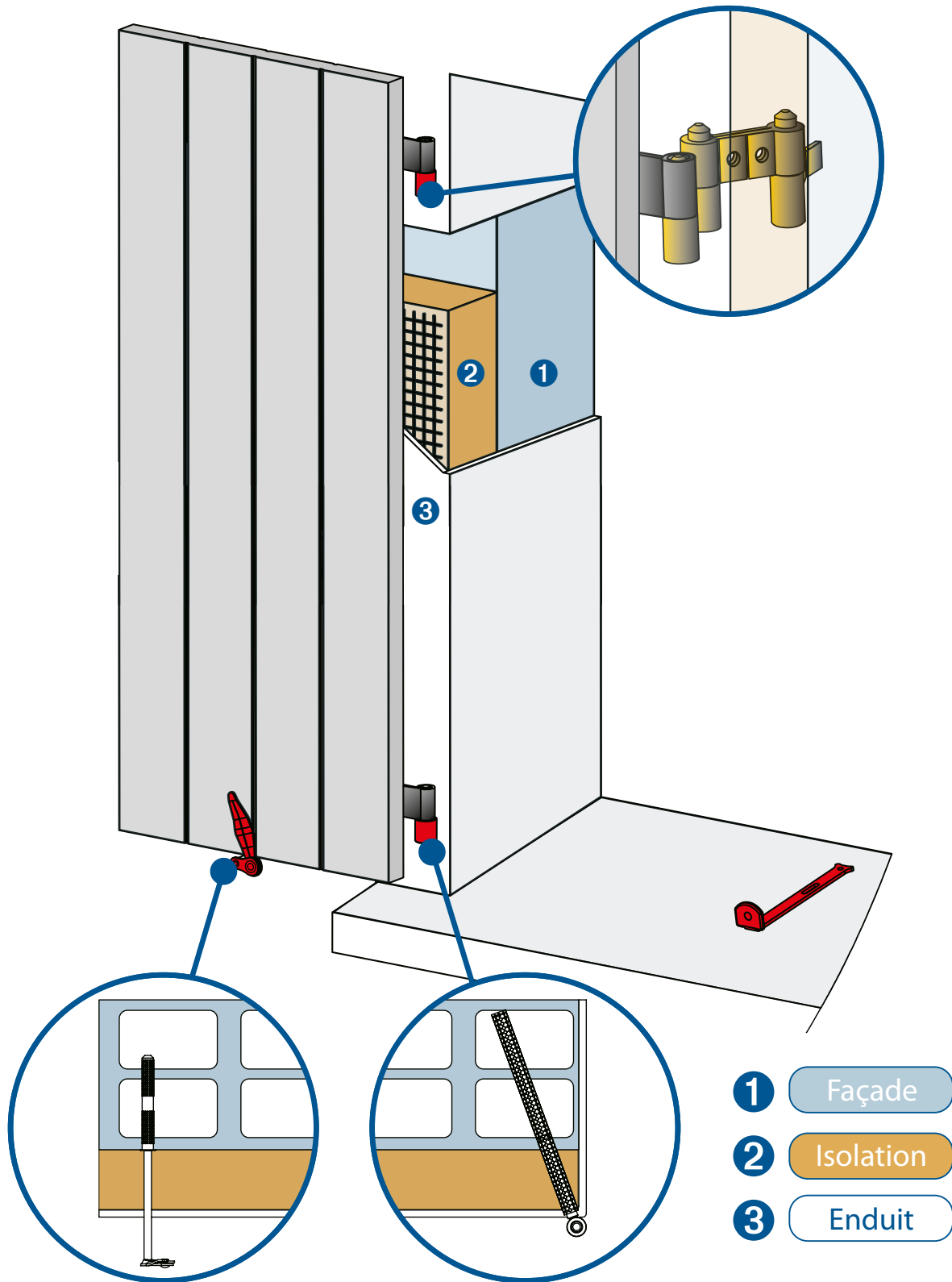

Gond à scellement chimique composite (kit)

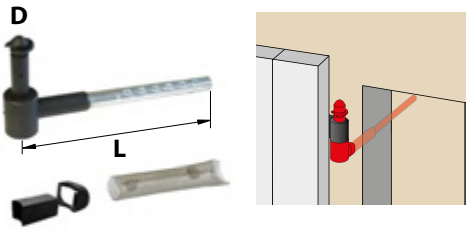

Code	Gencod		D	L	Type packaging	
0419401	3308184194018		14	180	Vrac gencodé	1
0432501	3308184325016		14	300	Vrac gencodé	1

Composition
 1 gond
 1 entretoise
 1 bague de propreté
 1 tamis métallique

Gond à scellement chimique acier (kit)

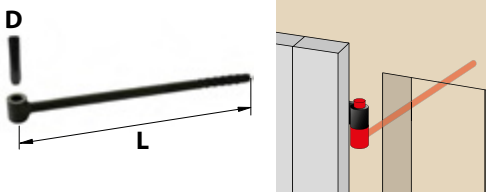

Code	Gencod		D	D2	L	Type packaging	
0443501	3308184435012		14	14	180	Vrac gencodé	1
0467801	3308184678013		14	14	300	Vrac gencodé	1
61ISOXT35M	3517650578676		14	20	350	Vrac gencodé	10

Composition
 1 gond
 1 tamis métallique
 1 élastique

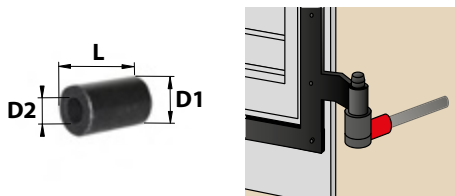

Entretoise pour gond acier (x2)

Code	Gencod		L	D1	D2	Type packaging	
0952701	3308189527019		43,2	20	11	Brochable gencodé	1

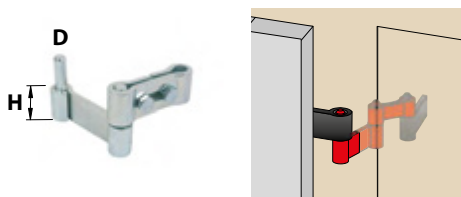

Gond pour isolation extérieure Isogond

Code	Gencod		D	H	Ep.	Type packaging	
0417303	3308184173037	Z.BLANC	14	30	5	Vrac gencodé	1
0417403	3308184174034	Z.BLANC	16	30	5	Vrac gencodé	1

Arrêts de volets à visser



La mise en œuvre des fermetures est encadrée par le DTU 34-4, s'y référer pour éviter tout danger.

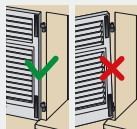

Bien s'assurer que le vantail soit monté plaqué et serré sur la façade.



En cas de vent, fermer les volets.



Pour les volets de grandes tailles, utiliser uniquement les arrêts adaptés.



Conseils de pose P.138



Plus d'infos sur www.afbat.com

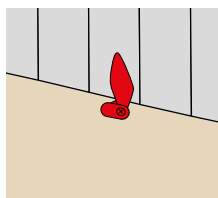
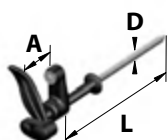

Tourniquet marseillais composite à visser *

Code	Gencod		D	L	A	Type packaging	
0418501	3308184185016		10	280	12/116	Vrac gencodé	1
0418702	3308184187027		10	280	12/116	Vrac gencodé	1

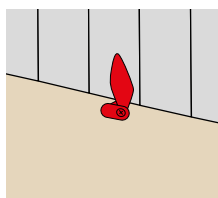

Tourniquet marseillais acier à visser *

Code	Gencod		D	L	Type packaging	
0426701	3308184267019		10	180		20
0417501	3308184175017		10	250	Vrac gencodé	1

Arrêts tête bergère à visser

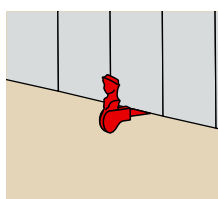
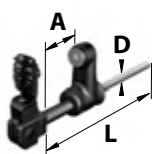

Arret tête bergère composite à visser *

Code	Gencod		D	L	A	Type packaging	
0418801	3308184188017		10	280	22/115	Vrac gencodé	1

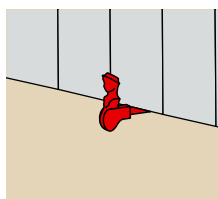

Arret tête bergère acier à visser *

Code	Gencod		D	L	Type packaging	
0787501	3308187875013		10	250	Vrac gencodé	5



L'EXTÉRIEUR DE L'HABITAT

LA SÉCURITÉ DU VOLET

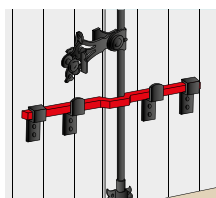
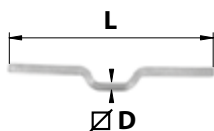

Barre de sécurité renforcée

Code	Gencod		∅ D	L	Type packaging	
0640903	3308186409035	Z.BLANC	16	410	Vrac gencodé	1
0705903	3308187059031	Z.BLANC	16	980	Vrac gencodé	1
0706003	3308187060037	Z.BLANC	16	1480	Vrac gencodé	1

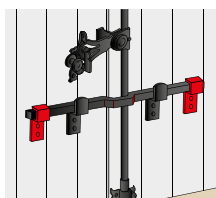

Support antisoulèvement barre de sécurité pour carré 16

Code	Gencod		L	H	Ep.	Type packaging	
(x1)							
0802103	3308180030778	Z.BLANC	25	69,5	3,5	Vrac gencodé	10
0247403	3308182474037	Z.BLANC	25	69,5	3,5		100
(x2)							
0711603	3308187116031	Z.BLANC	25	69,5	3,5	Brochable gencodé	1

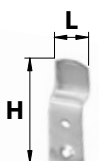

Support simple barre de sécurité pour carré 16

Code	Gencod		L	H	Ep.	Type packaging	
(x1)							
0801903	3308180030761	Z.BLANC	25	75	3,5	Vrac gencodé	10
0247503	3308182475034	Z.BLANC	25	75	3,5		100

Support simple (x2) + contre-plaque (x2)

0711504	3308187115041		25	75	3,5	Brochable gencodé	1
0711503	3308187115034	Z.BLANC	25	75	3,5	Brochable gencodé	1

Support simple barre (x4) + Visserie

0409203	3308184092031	Z.BLANC	25	75	3,5	Brochable gencodé	1
---------	---------------	---------	----	----	-----	-------------------	---

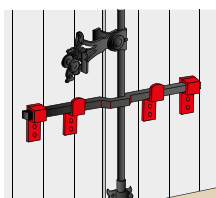

Kit support barre de sécurité pour carré 16

Code	Gencod		Type packaging	
Support simple (x2) + antisoulèvement (x2) + Visserie				
0318104	3308183181040		Vrac gencodé	1
0318103	3308183181033	Z.BLANC	Vrac gencodé	1
Support simple (x2) + antisoulèvement (x2) + contre-plaques (x4) + Visserie				
0409103	3308184091034	Z.BLANC	Brochable gencodé	1

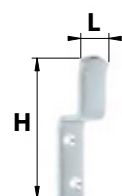

Support ouvert barre de sécurité

Code	Gencod		L	H	Type packaging	
Pour carré de 25 mm						
6139025	3221686139250	Z.BLANC	20	94	Vrac gencodé	10
Pour carré de 25 à 36 mm						
6139036	3221686139366	Z.BLANC	20	94	Vrac gencodé	10

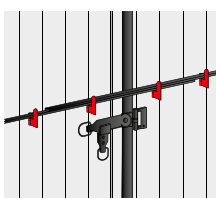
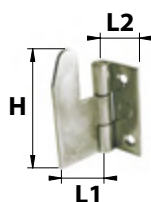

Support charnière pour barre de sécurité 12 mm

Code	Gencod		L1	L2	H	Ep.	Type packaging	
A visser - Modèle droite								
538130	3479045381301	Z.BLANC	34	23,5	67	2	Vrac gencodé	10
A visser - Modèle gauche								
538140	3479045381400	Z.BLANC	34	23,5	67	2	Vrac gencodé	10

Modèle droite

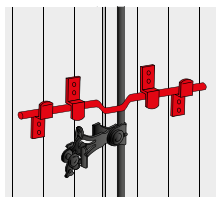
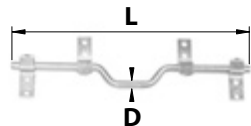

Barre de sécurité ronde

Code	Gencod		∅ D	L	Type packaging	
0337103	3308183371038	Z.BLANC	14	410	Brochable gencodé	1

Composition
 1 barre de sécurité L41 cm
 4 supports droits
 Visserie

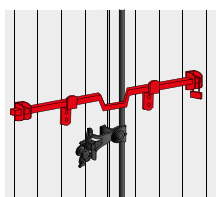
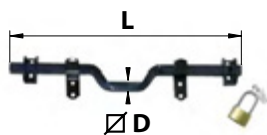

Barre de sécurité renforcée + cadenas

Code	Gencod		∅ D	L	Type packaging	
0337504	3308183375043		16	410	Brochable gencodé	1

Composition
 1 barre de sécurité L41 cm percée pour passage du cadenas
 2 supports droits + 2 supports sécurité
 1 cadenas
 Visserie

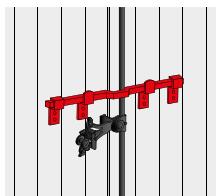
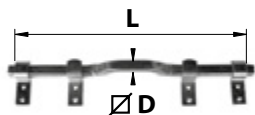

Barre de sécurité renforcée

Code	Gencod		∅ D	L	Type packaging	
0707004	3308180029949		16	410	Brochable gencodé	1
0802204	3308188022041		16	980	Brochable gencodé	1
0707003	3308187070036	Z.BLANC	16	410	Brochable gencodé	1
0802203	3308180029796	Z.BLANC	16	980	Brochable gencodé	1

Composition
 1 barre de sécurité
 2 supports simples
 2 supports anti-soulèvements
 4 contre-plaques (uniquement pour L98 cm)
 Visserie

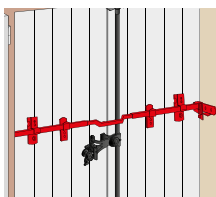
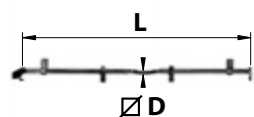

Barre de sécurité réglable 6 points

Code	Gencod		∅ D	L	Type packaging	
0704404	3308187044044		16	410	Brochable gencodé	1

Composition
 1 barre de sécurité L41 cm
 2 rallonges
 2 supports intermédiaires
 2 supports verrous
 2 supports tableau

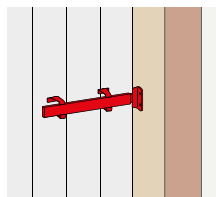
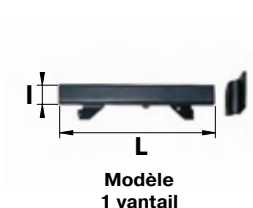

Barre de sécurité verrou

Code	Gencod		L	I	Type packaging	
1 vantail						
0337706	3308183377061		245	30	Brochable gencodé	1
2 vantaux						
0777406	3308180029802		245 + 245	30	Brochable gencodé	1

Composition

Pour 1 vantail :

- 1 fourreau avec pêne cadenassable
- 1 gâche murale à visser
- Visserie

Pour 2 vantaux :

- 1 fourreau avec pêne cadenassable
- 1 fourreau sans pêne
- Visserie

Barre de sécurité à boutons

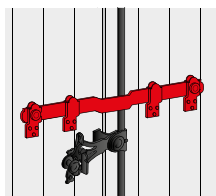

Code	Gencod		L	Type packaging	
0318304	3308183183044		450	Brochable gencodé	1

Composition

- 1 barre de sécurité L450 mm
- 2 supports simples
- 2 supports antisoulèvement
- Visserie

Barre de sécurité plate à ergots

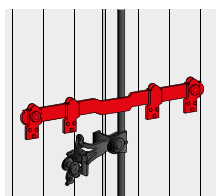
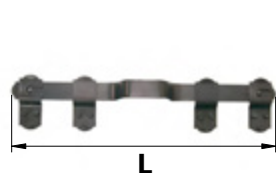

Code	Gencod		L	Type packaging	
Acier					
0174403	3308181744032	Z.BLANC	450	Brochable gencodé	1
Aluminium					
0312906	3308183129066		450	Brochable gencodé	1
0312926	3308183129264		450	Brochable gencodé	1

Composition

- 1 barre de sécurité L450 mm
- 2 supports simples
- 2 supports antisoulèvement
- Visserie

Entrebâilleur de volet

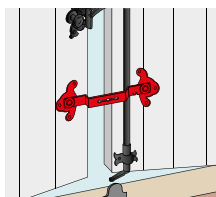
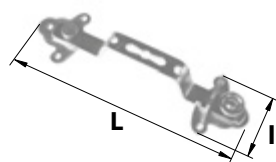

Code	Gencod		L	I	Type packaging	
0700104	3308180040555		285	83	Brochable gencodé	1
0700103	3308187001030	Z.BLANC	285	83	Brochable gencodé	1
0942703	3308189427036	Z.BLANC	285	83		5



L'EXTÉRIEUR DE L'HABITAT

LES PERSIENNES

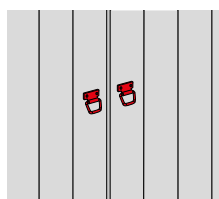
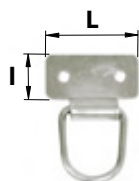

Anneau de tirage (x2)

Code	Gencod		L	I	Type packaging	
0952303	3308189523035	Z.BLANC	40	20	Brochable gencodé	1

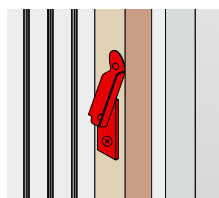

Modèle gauche

Arrêt de persienne à visser

Code	Gencod		L	I	H	Ep.	Type packaging		
Modèle droite									
0382703	3308183827030	Z.BLANC	90	20	60	3	Vrac gencodé	10	
Modèle gauche									
0382603	3308183826033	Z.BLANC	90	20	60	3	Vrac gencodé	10	
Modèle droite + gauche									
0701503	3308187015037	Z.BLANC	90	20	60	3	Brochable gencodé	1	

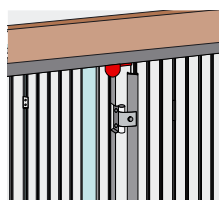

Butée de persienne à visser

Code	Gencod		L	I	H	Ep.	Type packaging		
Modèle haut									
538071	3221685380714		30	23	27	2,5	Vrac gencodé	10	
538070	3479045380700	Z.BLANC	30	23	27	2,5	Vrac gencodé	10	
0961603	3308189616034	Z.BLANC	30	20	31	2,5	Brochable gencodé	1	
Modèle bas									
538081	3479045380816		30	30	30	2,5	Vrac gencodé	10	
538080	3479045380809	Z.BLANC	30	30	30	2,5	Vrac gencodé	10	
538090	3479045380908	Z.BLANC	30	23	36	2,5	Vrac gencodé	10	
0961503	3308189615037	Z.BLANC	30	30,5	30	2,5	Brochable gencodé	1	

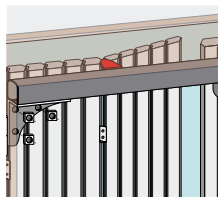
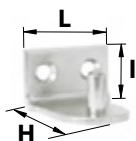

Crochet de rappel

Code	Gencod		L	I	H	Ep.	Type packaging	
0962803	3308189628037	Z.BLANC	30	20	31	2,5	Brochable gencodé	1

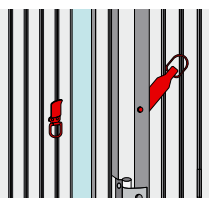

Loquet droit + support

Code	Gencod		L	Ep.	Type packaging	
0957303	3308189573030	Z.BLANC	98	2,5	Brochable gencodé	1

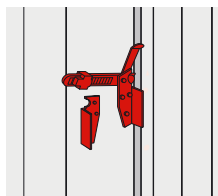

Loquet de persienne + support

Code	Gencod		L	Ep.	Type packaging	
0963916	3308189639163	GRIS	201	2,5	Brochable gencodé	1

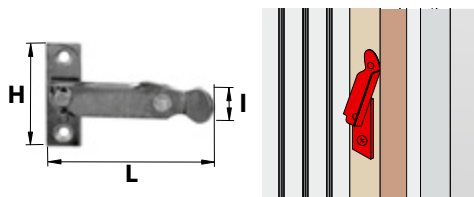

Modèle droite

Arrêt de persienne inox à visser + butée

Code	Gencod		L	I	H	Ep.	Type packaging	
Modèle droite								
0960500	3308189605007	304L	113,5	21	62	2	Vrac gencodé	1
Modèle gauche								
0960600	3308189606004	304L	113,5	21	62	2	Vrac gencodé	1

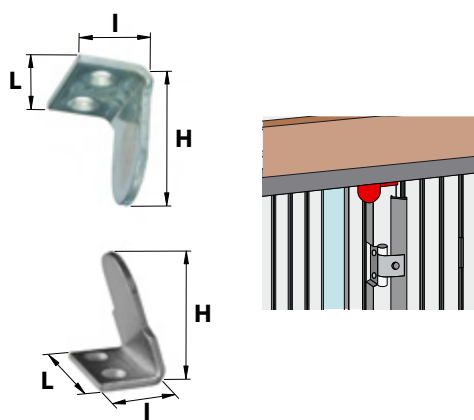

Butée de persienne inox à visser

Code	Gencod		L	I	H	Ep.	Type packaging	
Modèle haut								
0962703	3308189627030	304L	30	20	30,5	2	Brochable gencodé	1
Modèle bas								
0961403	3308189614030	304L	30	20	40	2	Brochable gencodé	1

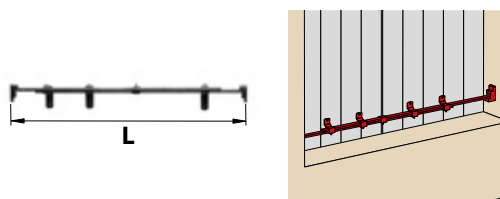

Barre de sécurité persienne recoupable

Code	Gencod		L	Type packaging	
0704203	3308187042033	Z.BLANC	1600	Brochable gencodé	1



L'EXTÉRIEUR DE L'HABITAT

LE VOLET ROULANT

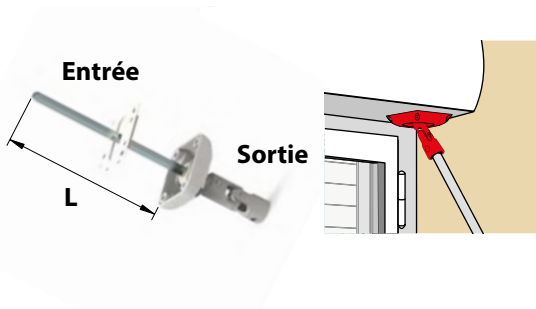

Sortie de caisson à 45°

Code	Gencod		L	Entrée	Sortie	Type packaging	
0840900	3308188409002	<input type="text"/>	315	● 7	● 12	Brochable gencodé	1

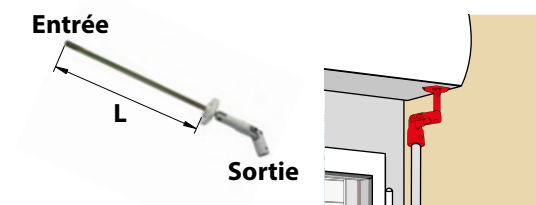

Sortie de caisson déportée

Code	Gencod		L	Entrée	Sortie	Type packaging	
0841200	3308188412002	<input type="text"/>	210	● 7	● 12	Brochable gencodé	1

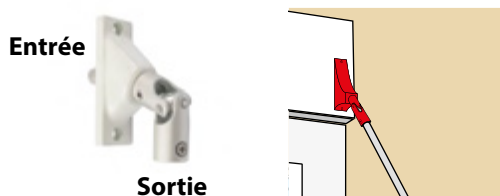

Sortie de caisson treuil à 90° + double cadran

Code	Gencod		Entrée	Sortie	Type packaging	
0841300	3308188413009	<input type="text"/>	● 7	● 12	Brochable gencodé	1

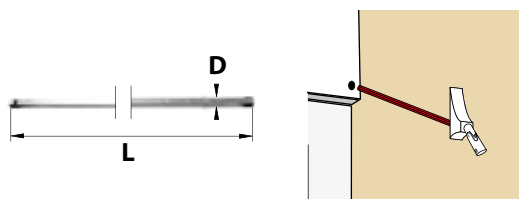

Tige passe-caisson recoupable

Code	Gencod		L	D	Type packaging	
0840700	3308188407008	Z.BLANC	300	● 7	Vrac gencodé	1

Entrée



Sortie

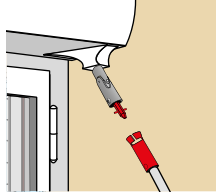

Kit manivelle décrochable

Code	Gencod		Entrée	Sortie	Type packaging	
0851500	3308188515000	<input type="text"/>	● 10	● 12	Brochable gencodé	1



Sortie

Entrée

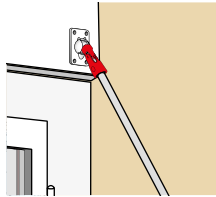

Genouillère acier chrome

Code	Gencod		Entrée	Sortie	Type packaging	
0842200	3308188422001	CHROME	● 7	● 12	Brochable gencodé	1
0842800	3308188428003	CHROME	● 10	● 12	Brochable gencodé	1
0842400	3308188424005	CHROME	● 10	● 10	Brochable gencodé	1
0842600	3308188426009	CHROME	● 12	● 12	Brochable gencodé	1



Sortie

Entrée

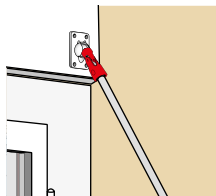

Genouillère acier laqué

Code	Gencod		Entrée	Sortie	Type packaging	
0877600	3308188776005	<input type="text"/>	● 7	● 12	Brochable gencodé	1
0878100	3308188781009	<input type="text"/>	● 10	● 12	Brochable gencodé	1
0877700	3308188777002	<input type="text"/>	● 10	● 10	Brochable gencodé	1
0877900	3308188779006	<input type="text"/>	● 12	● 12	Brochable gencodé	1

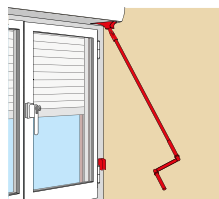
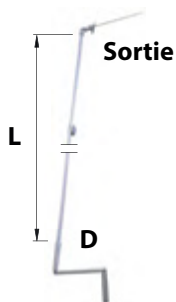

Kit manivelle complet classic

Code	Gencod		Sortie	D	L	Type packaging	
0843500	3308188435001	<input type="text"/>	● 7	● 12	1100	Vrac gencodé	1
0963800	3308189638005	<input type="text"/>	● 10	● 12	1100	Vrac gencodé	1

Composition

- 1 sortie de caisson
- 1 tringle
- 1 poignée manivelle
- 1 bloqueur de manivelle
- Visserie

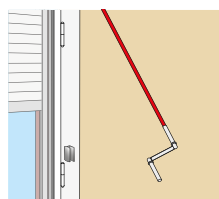
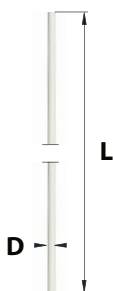

Tringle manivelle

Code	Gencod		D	L	Type packaging	
0843700	3308188437005	<input type="text"/>	● 12	900	Vrac gencodé	1
0843600	3308188436008	<input type="text"/>	● 12	1100	Vrac gencodé	1

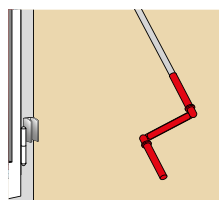

Poignée de manivelle pour tringle Ø12 mm

Code	Gencod		Type packaging	
0843200	3308188432000	<input type="text"/>	Brochable gencodé	1

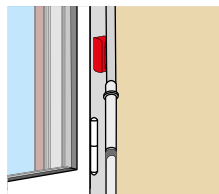

Bloqueur de manivelle magnétique

Code	Gencod		Type packaging	
Pour manivelle acier ● 12 mm et ● 10 mm				
0844000	3308188440005	<input type="text"/>	Brochable gencodé	1

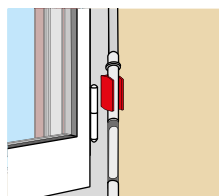

Bloqueur de manivelle design

Code	Gencod		Type packaging	
Pour manivelle acier ● 12 mm				
0841100	3308188411005	<input type="text"/>	Brochable gencodé	1

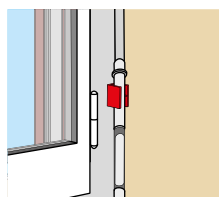

Bloqueur de manivelle classic

Code	Gencod		Type packaging	
Pour manivelle acier ● 12 mm				
0844100	3308188441002	<input type="text"/>	Brochable gencodé	1

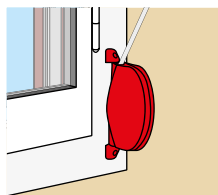

Enrouleur sous carter pivotant pour sangle 14/15 mm

Code	Gencod		Type packaging	
0846200	3308188462007	<input type="text"/>	Vrac gencodé	1

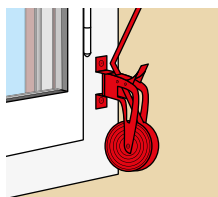

Enrouleur pivotant pour sangle 20/22 mm

Code	Gencod		Type packaging	
0846500	3308188465008	Z.BLANC	Vrac gencodé	1

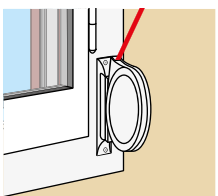

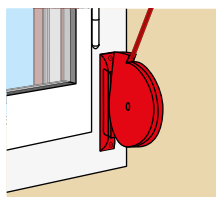

Sangle

Code	Gencod		L	Type packaging	
114/15 mm					
0850500	3308188505001	<input type="text"/>	6000	Brochable gencodé	1
0933400	3308189334006	<input type="text"/>	6000		10
120/22 mm					
0851000	3308188510005	<input type="text"/>	5500	Brochable gencodé	1





**Enrouleur pivotant réglable
+ sangle 14/15 mm L5,8m**

Code	Gencod		Type packaging	
0957100	3308189571005	<input type="checkbox"/>	Brochable gencodé	1
0845100	3308188451001	<input type="checkbox"/>	Brochable gencodé	1

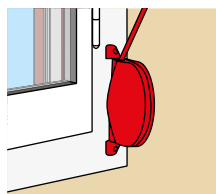
Mise en tension et changement de la sangle possible sans démonter le boîtier.



Enrouleur sous carter pivotant + sangle 14/15 mm L6m

Code	Gencod		Type packaging	
0957000	3308189570008	<input type="checkbox"/>	Vrac gencodé	1
0844800	3308188448001	<input type="checkbox"/>	Brochable gencodé	1
0933300	3308189333009	<input type="checkbox"/>		4

Accessoires volets roulants à sangle



14/15 mm

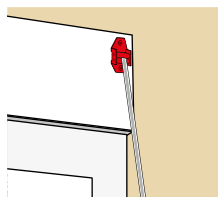

20/22 mm

Guide-sangle classic

Code	Gencod		Type packaging	
Pose horizontale pour sangle I14/15 mm				
0848700	3308188487000	<input type="checkbox"/>	Brochable gencodé	1
Pose verticale pour sangle I20/22 mm				
0848600	3308188486003	<input type="checkbox"/>	Brochable gencodé	1



14/15 mm

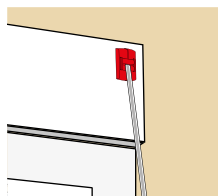

Guide-sangle design

Code	Gencod		Type packaging	
Pose horizontale + fixations invisibles				
0849500	3308188495005	<input type="checkbox"/>	Brochable gencodé	1
Pose verticale + fixations invisibles				
0849000	3308188490000	<input type="checkbox"/>	Brochable gencodé	1

Accessoires volets roulants à cordon

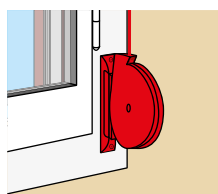

Enrouleur pivotant réglable à cordon

Code	Gencod		Type packaging	
0956900	3308189569002	<input type="checkbox"/>	Brochable gencodé	1

Accessoires volets roulants à chaîne

Ø4,5 mm

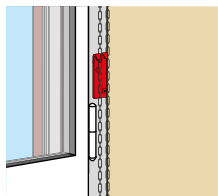

Arrêt de chaîne

Code	Gencod		Type packaging	
0851400	3308188514003	Z.BLANC	Brochable gencodé	1



14/22 mm

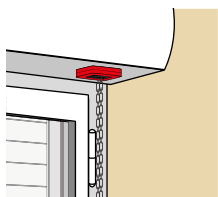

Guide STOPVENT chaîne ou sangle

Code	Gencod		Type packaging	
0847500	3308188475007		Brochable gencodé	1

Accessoires volets roulants à tirage direct

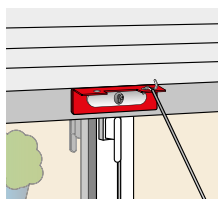
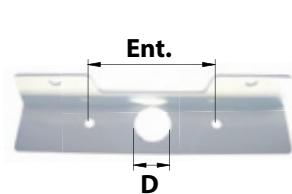

Poignée de tirage

Code	Gencod		D	Ent.	Type packaging	
0851900	3308188519008		25	90	Brochable gencodé	1

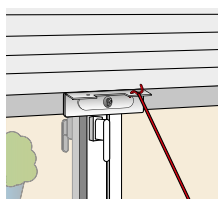

Bâton de tirage

Code	Gencod		L	Type packaging	
0851800	3308188518001		1000	Brochable gencodé	1

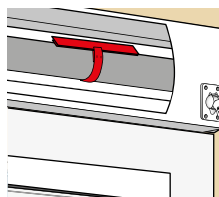

Attache souple lame épaisse (x2)

Code	Gencod		L	Type packaging	
------	--------	--	---	----------------	--

Pour tablier court

0881200	3308188812000		140	Brochable gencodé	1
---------	---------------	--	-----	-------------------	---

Pour tablier long

0842000	3308188420007		180	Brochable gencodé	1
---------	---------------	--	-----	-------------------	---

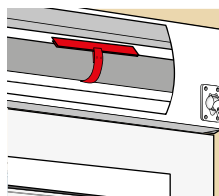
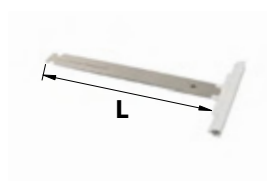

Attache souple lame souple (x2)

Code	Gencod		L	Type packaging	
------	--------	--	---	----------------	--

Pour tablier court

0843950	3308188439504		150	Brochable gencodé	1
---------	---------------	--	-----	-------------------	---

Pour tablier long

0843980	3308188439801		180	Brochable gencodé	1
---------	---------------	--	-----	-------------------	---

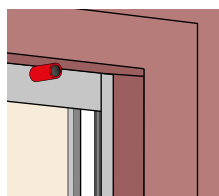
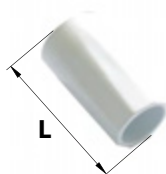

Butée de lame finale (x2)

Code	Gencod		L	Type packaging	
------	--------	--	---	----------------	--

0851300	3308188513006		40	Brochable gencodé	1
---------	---------------	--	----	-------------------	---

0851200	3308188512009		40	Brochable gencodé	1
---------	---------------	--	----	-------------------	---

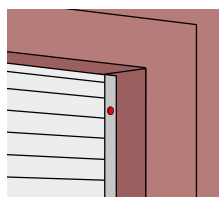
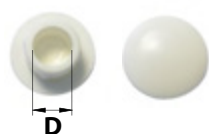

Bouchon de protection (x10)

Code	Gencod		D	Type packaging	
------	--------	--	---	----------------	--

0851700	3308188517004		10	Brochable gencodé	1
---------	---------------	--	----	-------------------	---

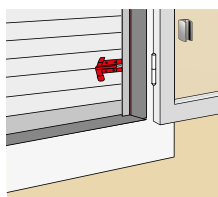

Verrou antisoulèvement (x2)

Code	Gencod		Type packaging	
1018302	3308180183023	Z.BLANC	Brochable gencodé	1

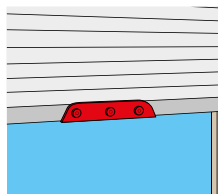

Barre de verrouillage volet roulant

Code	Gencod		Type packaging	
0700426	3308187004260		Brochable gencodé	1

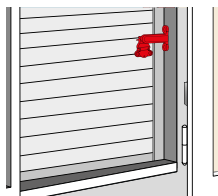

Kit verrouillage automatique volet roulant

Code	Gencod		Type packaging	
0996500	3308189965002		Brochable gencodé	1

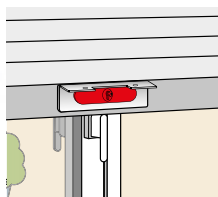

Serrure extraplate 3 clés

Code	Gencod		Type packaging	
0851600	3308188516007		Brochable gencodé	1